

N Cord Grips



E-mail: info@sabcable.com



Web site: www.sabcable.com

Chapter

Item	Description	Page
Polyamide 6 Cord Grips		
CG 100 Metric	Polyamide cord grip, dome cap, black or gray, metric thread	N 3
CG 100 PG	Polyamide cord grip, dome cap, black or gray, PG thread	N 4
CG 100 NPT	Polyamide cord grip, dome cap, black or gray, NPT thread	N 5
CG 200 Metric	Polyamide cord grip, flex cap, black or gray, metric thread	N 6
CG 200 PG	Polyamide cord grip, flex cap, black or gray, PG thread	N 7
CG 200 NPT	Polyamide cord grip, flex cap, black or gray, NPT thread	N 7
Locknuts	Polyamide locknuts, black or gray, metric & PG & NPT thread	N 8
Metal Cord Grips		
CG 300 Metric	Nickel plated brass cord grip, standard & longer thread, metric thread	N 9
CG 300 PG	Nickel plated brass cord grip, standard & longer thread, PG thread	N 10
CG 300 NPT	Nickel plated brass cord grip, NPT thread	N 10
CG 350 Metric	Stainless steel cord grip, SS303 or SS316, metric thread	N 11
CG 350 PG	Stainless steel cord grip, SS303 or SS316, PG thread	N 11
Locknuts	Nickel plated brass locknuts, metric & PG thread	N 16
EMC Grounding Cord Grips		
CG EMC-2 Metric	Nickel plated brass EMC cable gland, standard & longer thread, metric thread	N 13
CG EMC-2 PG	Nickel plated brass EMC cable gland, standard & longer thread, PG thread . .	N 14
CG EMC-2 NPT	Nickel plated brass EMC cable gland, NPT thread	N 14
CG EMC-4 Metric	Nickel plated brass EMC cable gland, vibration proof, metric thread	N 15
CG EMC-4 PG	Nickel plated brass EMC cable gland, vibration proof, PG thread	N 15
CG EMC-4 NPT	Nickel plated brass EMC cable gland, vibration proof, NPT thread	N 15
EMC Locknuts	Nickel plated brass locknuts with grounding teeth, metric & PG thread	N 16
Cable Gland Accessories & Fittings		
Enlargers	Nickel plated brass fittings, PG to PG, Metric to PG, Metric to Metric	N 17
Reducers	Nickel plated brass fittings, PG to PG, Metric to PG, Metric to Metric	N 18
Multi-Hole Bushing	NBR multi-hole bushing for use with metric, PG or NPT cord grips	N 19
Hole Plug	Round or Hex polyamide hole plugs, black or gray, metric or PG threads	N 20
Stainless Steel Hygienic Cable Gland and Conduit Fitting		
CG Clean	Stainless steel hygienic cable gland, standard and EMC, metric threads	N 22
CF Clean	Stainless Steel hygienic conduit fitting, metric threads	N 23
Ventilation Glands & Plugs		
VG Vent PA6	Polyamide vent gland, black or gray, metric & PG thread	N 24
VG Vent NPB	Nickel plated brass vent gland, metric & PG thread	N 24
VP Vent PA6	Polyamide vent plug, black or gray, metric thread or quick fit	N 25
VP Vent NPB	Stainless steel vent plug, metric & PG thread	N 26

CG 100 METRIC POLYAMIDE CABLE GLANDS

METRIC THREAD

Liquid tight seal, fast and easy installation, wide clamping range, multi-purpose applications, easy handling.

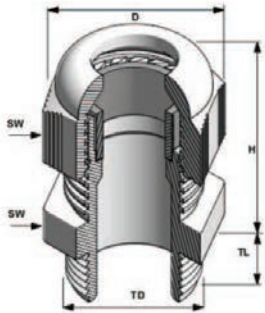

Technical details:

Material:	Polyamide 6
Seal:	Chloroprene (CR)
Color:	RAL 7001 (gray) RAL 9005 (black)
Protection Class:	IP 68 - 5 Bar
Temperature range	
<i>permanent:</i>	-20°C to +100°C
<i>intermittent:</i>	-30°C to +150°C
Flammability:	V2 (according to UL 94)
Approvals:	UL, UR, cCSAus, VDE, DNV-GL, CE

Part Number		Thread Type	Clamping Range Ø min-max		Thread Diameter (TD)		Wrenching Flats (SW)		Thread Length (TL)	Height (H)	UL
gray	black		inches	mm	inches	mm	inches	mm			
Metric											
PMG-12	PMB-12	M12x1.5	.118 - .256	3.0 - 6.5	0.472	12	0.591	15	0.315	0.886	UR
PMG-16*	PMB-16*	M16x1.5	.197 - .394	5.0 - 10.0	0.630	16	0.866	22	0.394	1.181	UR
PMG-20*	PMB-20*	M20x1.5	.236 - .473	6.0 - 12.0	0.787	20	0.945	24	0.394	1.161	UL
PMG-20C*	PMB-20C*	M20x1.5	.394 - .552	10.0 - 14.0	0.787	20	1.063	27	0.394	1.220	UL
PMG-25*	PMB-25*	M25x1.5	.512 - .709	13.0 - 18.0	0.984	25	1.299	33	0.394	1.457	UL
PMG-32	PMB-32	M32x1.5	.709 - .984	18.0 - 25.0	1.260	32	1.654	42	0.591	1.614	UL
PMG-40	PMB-40	M40x1.5	.866 - 1.260	22.0 - 32.0	1.575	40	2.087	53	0.709	2.028	UL
PMG-50	PMB-50	M50x1.5	1.181 - 1.496	30.0 - 38.0	1.969	50	2.362	60	0.709	2.087	UL
PMG-63	PMB-63	M63x1.5	1.339 - 1.732	34.0 - 44.0	2.480	63	2.559	65	0.709	2.087	UL
Metric with Reducer Bushings											
PMG-12R	PMB-12R	M12x1.5	.079 - .197	2.0 - 5.0	0.472	12	0.591	15	0.315	0.886	UR ¹
PMG-16R*	PMB-16R*	M16x1.5	.118 - .276	3.0 - 7.0	0.630	16	0.866	22	0.394	1.181	UR ¹
PMG-20R*	PMB-20R*	M20x1.5	.197 - .355	5.0 - 9.0	0.787	20	0.945	24	0.394	1.161	UL ¹
PMG-20RC*	PMB-20RC*	M20x1.5	.276 - .473	7.0 - 12.0	0.787	20	1.063	27	0.394	1.220	UL ¹
PMG-25R*	PMB-25R*	M25x1.5	.354 - .630	9.0 - 16.0	0.984	25	1.299	33	0.394	1.457	UL ¹
PMG-32R	PMB-32R	M32x1.5	.472 - .788	12.0 - 20.0	1.260	32	1.654	42	0.591	1.614	UL ¹
PMG-40R	PMB-40R	M40x1.5	.788 - 1.024	20.0 - 26.0	1.575	40	2.087	53	0.709	2.028	UL ¹
PMG-50R	PMB-50R	M50x1.5	.984 - 1.220	25.0 - 31.0	1.969	50	2.362	60	0.709	2.087	UL ¹
PMG-63R	PMB-63R	M63x1.5	1.142 - 1.378	29.0 - 35.0	2.480	63	2.559	65	0.709	2.087	UL ¹

Locknut included

*Available with longer thread

¹Product is UR/UL tested to cCSAus

E-mail: info@sabcable.com



Web site: www.sabcable.com

CG 100 PG POLYAMIDE CABLE GLANDS

PG THREAD

Liquid tight seal, fast and easy installation, wide clamping range, multi-purpose applications, easy handling.

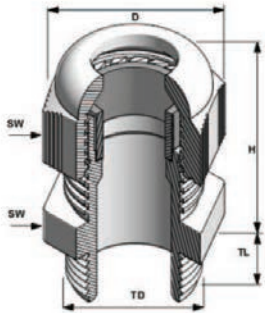

Technical details:

Material:	Polyamide 6
Seal:	Chloroprene (CR)
Color:	RAL 7001 (gray) RAL 9005 (black)
Protection Class:	IP 68 - 5 Bar
Temperature range	
<i>permanent:</i>	-20°C to +100°C
<i>intermittent:</i>	-30°C to +150°C
Flammability:	V2 (according to UL 94)
Approvals:	UL, UR, cCSAus, DNV-GL, CE

Part Number		Thread Type	Clamping Range Ø min-max		Thread Diameter (TD)		Wrenching Flats (SW)		Thread Length (TL)	Height (H)	UL
gray	black		inches	mm	inches	mm	inches	mm			
PG											
PPG-7	PPB-7	PG 7	.118 - .256	3.0 - 6.5	0.492	12.5	0.591	15	0.315	0.866	UR
PPG-9	PPB-9	PG 9	.157 - .315	4.0 - 8.0	0.598	15.2	0.748	19	0.315	1.043	UR
PPG-11	PPB-11	PG 11	.197 - .394	5.0 - 10.0	0.732	18.6	0.866	22	0.315	1.142	UR
PPG-13	PPB-13	PG 13.5	.236 - .472	6.0 - 12.0	0.803	20.4	0.945	24	0.394	1.142	UL
PPG-16	PPB-16	PG 16	.394 - .551	10.0 - 14.0	0.886	22.5	1.063	27	0.394	1.220	UL
PPG-21	PPB-21	PG 21	.512 - .709	13.0 - 18.0	1.114	28.3	1.299	33	0.433	1.457	UL
PPG-29	PPB-29	PG 29	.709 - .984	18.0 - 25.0	1.457	37.0	1.654	42	0.433	1.614	UL
PPG-36	PPB-36	PG 36	.866 - 1.261	22.0 - 32.0	1.850	47.0	2.087	53	0.512	2.028	UL
PPG-42	PPB-42	PG 42	1.181 - 1.496	30.0 - 38.0	2.126	54.0	2.362	60	0.512	2.106	UL
PPG-48	PPB-48	PG 48	1.339 - 1.732	34.0 - 44.0	2.335	59.3	2.559	65	0.552	2.106	UL
PG with Reducer Bushings											
PPG-7R	PPB-7R	PG 7	.079 - .197	2.0 - 5.0	0.492	12.5	0.591	15	0.315	0.866	UR ¹
PPG-9R	PPB-9R	PG 9	.079 - .236	2.0 - 6.0	0.598	15.2	0.748	19	0.315	1.043	UR ¹
PPG-11R	PPB-11R	PG 11	.118 - .276	3.0 - 7.0	0.732	18.6	0.866	22	0.315	1.142	UR ¹
PPG-13R	PPB-13R	PG 13.5	.197 - .355	5.0 - 9.0	0.803	20.4	0.945	24	0.394	1.142	UL ¹
PPG-16R	PPB-16R	PG 16	.276 - .473	7.0 - 12.0	0.886	22.5	1.063	27	0.394	1.220	UL ¹
PPG-21R	PPB-21R	PG 21	.354 - .630	9.0 - 16.0	1.114	28.3	1.299	33	0.433	1.457	UL ¹
PPG-29R	PPB-29R	PG 29	.472 - .788	12.0 - 20.0	1.457	37.0	1.654	42	0.433	1.614	UL ¹
PPG-36R	PPB-36R	PG 36	.788 - 1.024	20.0 - 26.0	1.850	47.0	2.087	53	0.512	2.028	UL ¹
PPG-42R	PPB-42R	PG 42	.984 - 1.220	25.0 - 31.0	2.126	54.0	2.362	60	0.512	2.106	UL ¹
PPG-48R	PPB-48R	PG 48	1.142 - 1.378	29.0 - 35.0	2.335	59.3	2.559	65	0.552	2.106	UL ¹

Locknut included

¹ Product is UR/UL tested to cCSAus

E-mail: info@sabcable.com



Web site: www.sabcable.com

CG 100 NPT POLYAMIDE CABLE GLANDS

NPT THREAD

Liquid tight seal, fast and easy installation, wide clamping range, multi-purpose applications, easy handling.

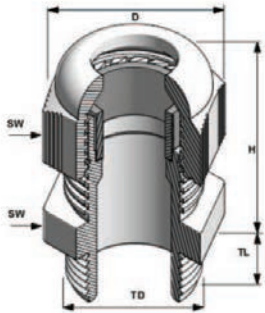

Technical details:

Material:	Polyamide 6
Seal:	Chloroprene (CR)
Color:	RAL 7001 (gray) RAL 9005 (black)
Protection Class:	IP 68 - 5 Bar
Temperature range	
<i>permanent:</i>	-20°C to +100°C
<i>intermittent:</i>	-30°C to +150°C
Flammability:	V2 (according to UL 94)
Approvals:	UL, UR, cCSAus, DNV-GL, CE

Part Number		Thread Type	Clamping Range Ø min-max		Thread Diameter (TD)		Wrenching Flats (SW)		Thread Length (TL)	Height (H)	UL
gray	black		inches	mm	inches	mm	inches	mm			
NPT											
PNG-3/8	PNB-3/8	NPT 3/8	.197 - .394	5.0 - 10.0	0.675	17.1	0.866	22	0.591	1.141	UR
PNG-1/2	PNB-1/2	NPT 1/2	.236 - .472	6.0 - 12.0	0.840	21.3	0.945	24	0.591	1.141	UL
PNG-1/2C	PNB-1/2C	NPT 1/2	.394 - .551	10.0 - 14.0	0.840	21.3	1.063	27	0.433	1.220	UL
PNG-3/4	PNB-3/4	NPT 3/4	.512 - .709	13.0 - 18.0	1.050	26.7	1.299	33	0.591	1.456	UL
PNG-1	PNB-1	NPT 1	.709 - .984	18.0 - 25.0	1.315	33.4	1.654	42	0.709	1.614	UL
NPT with Reducer Bushings											
PNG-3/8R	PNB-3/8R	NPT 3/8	.118 - .276	3.0 - 7.0	0.675	17.1	0.866	22	0.591	1.141	UR ¹
PNG-1/2R	PNB-1/2R	NPT 1/2	.197 - .354	5.0 - 9.0	0.840	21.3	0.945	24	0.591	1.141	UL ¹
PNG-1/2RC	PNB-1/2RC	NPT 1/2	.276 - .472	7.0 - 12.0	0.840	21.3	1.063	27	0.433	1.220	UL ¹
PNG-3/4R	PNB-3/4R	NPT 3/4	.354 - .630	9.0 - 16.0	1.050	26.7	1.299	33	0.591	1.456	UL ¹
PNG-1R	PNB-1R	NPT 1	.472 - .787	12.0 - 20.0	1.315	33.4	1.654	42	0.709	1.614	UL ¹

¹ Product is UR/UL tested to cCSAus

LOCKNUTS

Part Number		Thread Type	Height		Diameter		Wrenching Flats	
gray	black		inches	mm	inches	mm	inches	mm
NPT								
LNG-3/8	LNB-3/8	NPT 3/8	0.276	7	0.984	25.0	0.866	22
LNG-1/2	LNB-1/2	NPT 1/2	0.276	7	1.201	30.5	1.063	27
LNG-3/4	LNB-3/4	NPT 3/4	0.276	7	1.476	37.5	1.299	33
LNG-1	LNB-1	NPT 1	0.276	7	1.831	46.5	1.614	41

CG 200 METRIC SPIRAL CABLE GLANDS

METRIC THREAD

Strain relief gland offers maximum protection against conductor fatigue caused by flexing cables.

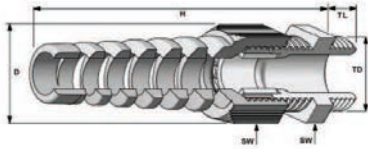

Technical details:

Material:	Polyamide 6
Seal:	Chloroprene (CR)
Color:	RAL 7001 (gray) RAL 9005 (black)
Protection Class:	IP 68 - 5 Bar
Temperature range	
<i>permanent:</i>	-20°C to +100°C
<i>intermittent:</i>	-30°C to +150°C
Flammability:	V2 (according to UL 94)
Approvals:	UL, UR, cCSAus, VDE, DNV-GL, CE

Part Number		Thread Type	Clamping Range Ø min-max		Thread Diameter (TD)		Wrenching Flats (SW)		Thread Length (TL)	Height (H)	UL
gray	black		inches	mm	inches	mm	inches	mm			
Metric*											
FMG-12	FMB-12	M12x1.5	.118 - .256	3.0 - 6.5	0.472	12	0.591	15	0.315	2.244	UR
FMG-16	FMB-16	M16x1.5	.197 - .394	5.0 - 10.0	0.630	16	0.866	22	0.394	3.209	UR
FMG-16L	FMB-16L	M16x1.5	.197 - .394	5.0 - 10.0	0.630	16	0.866	22	0.591	3.209	UR ¹
FMG-20	FMB-20	M20x1.5	.236 - .472	6.0 - 12.0	0.787	20	0.945	24	0.394	3.661	UL
FMG-20L	FMB-20L	M20x1.5	.236 - .472	6.0 - 12.0	0.787	20	0.945	24	0.591	3.661	UL ¹
FMG-20C	FMB-20C	M20x1.5	.394 - .551	10.0 - 14.0	0.787	20	1.063	27	0.394	4.173	UL
FMG-20CL	FMB-20CL	M20x1.5	.394 - .551	10.0 - 14.0	0.787	20	1.063	27	0.591	4.173	UL ¹
FMG-25	FMB-25	M25x1.5	.512 - .709	13.0 - 18.0	0.984	25	1.299	33	0.394	4.626	UL
FMG-25L	FMB-25L	M25x1.5	.512 - .709	13.0 - 18.0	0.984	25	1.299	33	0.591	4.626	UL ¹
Metric with Reducer Bushings											
FMG-12R	FMB-12R	M12x1.5	.079 - .197	2.0 - 5.0	0.472	12	0.591	15	0.315	2.244	UR ¹
FMG-16R	FMB-16R	M16x1.5	.118 - .276	3.0 - 7.0	0.630	16	0.866	22	0.394	3.209	UR ¹
FMG-16RL	FMB-16RL	M16x1.5	.118 - .276	3.0 - 7.0	0.630	16	0.866	22	0.591	3.209	UR ¹
FMG-20R	FMB-20R	M20x1.5	.197 - .354	5.0 - 9.0	0.787	20	0.945	24	0.394	3.661	UL ¹
FMG-20RL	FMB-20RL	M20x1.5	.197 - .354	5.0 - 9.0	0.787	20	0.945	24	0.591	3.661	UL ¹
FMG-20C	FMB-20C	M20x1.5	.276 - .472	7.0 - 12.0	0.787	20	1.063	27	0.394	4.173	UL ¹
FMG-20RCL	FMB-20RCL	M20x1.5	.276 - .472	7.0 - 12.0	0.787	20	1.063	27	0.591	4.173	UL ¹
FMG-25R	FMB-25R	M25x1.5	.354 - .630	9.0 - 16.0	0.984	25	1.299	33	0.394	4.626	UL ¹
FMG-25RL	FMB-25RL	M25x1.5	.354 - .630	9.0 - 16.0	0.984	25	1.299	33	0.591	4.626	UL ¹

"L" indicates longer thread
¹Product is UR/UL tested to cCSAus
 *VDE approval for metric only

CG 200 PG & NPT SPIRAL CABLE GLANDS

PG & NPT THREAD

Strain relief gland offers maximum protection against conductor fatigue caused by flexing cables.

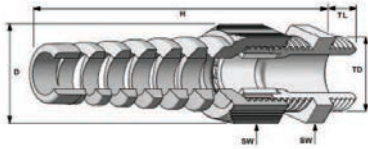

Technical details:

Material:	Polyamide 6
Seal:	Chloroprene (CR)
Color:	RAL 7001 (gray) RAL 9005 (black)
Protection Class:	IP 68 - 5 Bar
Temperature range	
<i>permanent:</i>	-20°C to +100°C
<i>intermittent:</i>	-30°C to +150°C
Flammability:	V2 (according to UL 94)
Approvals:	UL, UR, cCSAus, DNV-GL, CE

Part Number		Thread Type	Clamping Range Ø min-max		Thread Diameter (TD)		Wrenching Flats (SW)		Thread Length (TL)	Height (H)	UL
gray	black		inches	mm	inches	mm	inches	mm			
PG											
FPG-7	FPB-7	PG 7	.118 - .256	3.0 - 6.5	0.492	12.5	0.591	15	0.315	2.264	UR
FPG-9	FPB-9	PG 9	.157 - .315	4.0 - 8.0	0.598	15.2	0.748	19	0.315	2.732	UR
FPG-11	FPB-11	PG 11	.197 - .394	5.0 - 10.0	0.732	18.6	0.866	22	0.315	3.213	UR
FPG-13	FPB-13	PG 13.5	.236 - .472	6.0 - 12.0	0.803	20.4	0.945	24	0.394	3.681	UL
FPG-16	FPB-16	PG 16	.394 - .551	10.0 - 14.0	0.886	22.5	1.063	27	0.394	4.173	UL
FPG-21	FPB-21	PG 21	.512 - .709	13.0 - 18.0	1.114	28.3	1.299	33	0.433	4.642	UL
PG with Reducer Bushings											
FPG-7R	FPB-7R	PG 7	.079 - .197	2.0 - 5.0	0.492	12.5	0.591	15	0.315	2.264	UR ¹
FPG-9R	FPB-9R	PG 9	.079 - .236	2.0 - 6.0	0.598	15.2	0.748	19	0.315	2.732	UR ¹
FPG-11R	FPB-11R	PG 11	.118 - .276	3.0 - 7.0	0.732	18.6	0.866	22	0.315	3.213	UR ¹
FPG-13R	FPB-13R	PG 13.5	.197 - .354	5.0 - 9.0	0.803	20.4	0.945	24	0.394	3.681	UL ¹
FPG-16R	FPB-16R	PG 16	.276 - .472	7.0 - 12.0	0.886	22.5	1.063	27	0.394	4.173	UL ¹
FPG-21R	FPB-21R	PG 21	.354 - .630	9.0 - 16.0	1.114	28.3	1.299	33	0.433	4.642	UL ¹
NPT											
FNG-3/8	FNB-3/8	NPT 3/8	.197 - .394	5.0 - 10.0	0.675	17.1	0.866	22	0.591	3.169	UR
FNG-1/2	FNB-1/2	NPT 1/2	.236 - .472	6.0 - 12.0	0.840	21.3	0.945	24	0.591	3.720	UL
FNG-1/2C	FNB-1/2C	NPT 1/2	.394 - .551	10.0 - 14.0	0.840	21.3	1.063	27	0.591	4.173	UL
FNG-3/4	FNB-3/4	NPT 3/4	.512 - .709	13.0 - 18.0	1.050	26.7	1.299	33	0.591	4.606	UL
NPT with Reducer Bushings†											
FNG-3/8R	FNB-3/8R	NPT 3/8	.118 - .276	3.0 - 7.0	0.675	17.1	0.866	22	0.591	3.169	UR ¹
FNG-1/2R	FNB-1/2R	NPT 1/2	.197 - .354	5.0 - 9.0	0.840	21.3	0.945	24	0.591	3.720	UL ¹
FNG-1/2RC	FNB-1/2RC	NPT 1/2	.276 - .472	7.0 - 12.0	0.840	21.3	1.063	27	0.591	4.173	UL ¹
FNG-3/4R	FNB-3/4R	NPT 3/4	.354 - .630	9.0 - 16.0	1.050	26.7	1.299	33	0.591	4.606	UL ¹

¹ Product is UR/UL tested to cCSAus

POLYAMIDE LOCKNUTS

METRIC, PG & NPT

Hexagonal locknuts made of polyamide, glass fiber reinforced.

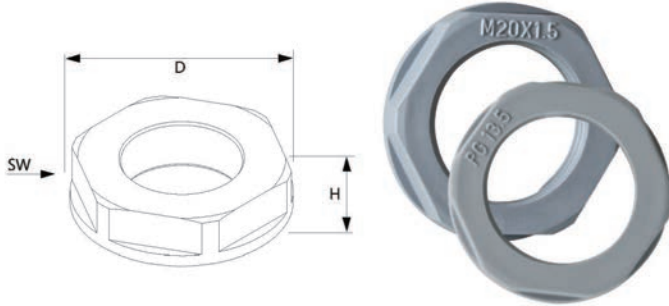

Technical details:

Material:	Polyamide 6 (30% Glass Fiber reinforced)
Color:	RAL 7001 (Gray) RAL 9005 (Black)
Temperature range <i>permanent:</i>	-20°C to +100°C
<i>intermittent:</i>	-30°C to +150°C
Flammability:	UL 94 HB

Part Number		Thread Type	Height (H)		Diameter (TD)		Wrenching Flats (SW)	
gray	black		inches	mm	inches	mm	inches	mm
Metric								
LMG-12	LMB-12	M12x1.5	0.197	5	0.768	19.5	0.709	18
LMG-16	LMB-16	M16x1.5	0.197	5	0.953	24.2	0.866	22
LMG-20	LMB-20	M20x1.5	0.236	6	1.126	28.6	1.024	26
LMG-25	LMB-25	M25x1.5	0.236	6	1.348	35.0	1.260	32
LMG-32	LMB-32	M32x1.5	0.276	7	1.815	46.1	1.614	41
LMG-40	LMB-40	M40x1.5	0.276	7	2.177	55.3	1.969	50
LMG-50	LMB-50	M50x1.5	0.315	8	2.602	66.1	2.362	60
LMG-63	LMB-63	M63x1.5	0.315	8	3.248	82.5	2.953	75
PG								
LPG-7	LPB-7	PG 7	0.197	5	0.827	21.0	0.748	19
LPG-9	LPB-9	PG 9	0.197	5	0.945	24.0	0.866	22
LPG-11	LPB-11	PG 11	0.197	5	1.024	26.0	0.945	24
LPG-13	LPB-13	PG 13.5	0.236	6	1.142	29.0	1.063	27
LPG-16	LPB-16	PG 16	0.236	6	1.299	33.0	1.181	30
LPG-21	LPB-21	PG 21	0.276	7	1.535	39.0	1.417	36
LPG-29	LPB-29	PG 29	0.276	7	1.969	50.0	1.811	46
LPG-36	LPB-36	PG 36	0.315	8	2.598	66.0	2.362	60
LPG-42	LPB-42	PG 42	0.315	8	2.874	73.0	2.559	65
LPG-48	LPB-48	PG 48	0.315	8	3.071	78.0	2.756	70
NPT								
LNG-3/8	LNB-3/8	NPT 3/8	0.276	7	0.984	25.0	0.866	22
LNG-1/2	LNB-1/2	NPT 1/2	0.276	7	1.201	30.5	1.063	27
LNG-3/4	LNB-3/4	NPT 3/4	0.276	7	1.476	37.5	1.299	33
LNG-1	LNB-1	NPT 1	0.276	7	1.831	46.5	1.614	41

CG 300 METRIC METAL CABLE GLANDS

METRIC THREAD

Impact resistant, suitable for industrial applications, water tight, corrosion resistant.

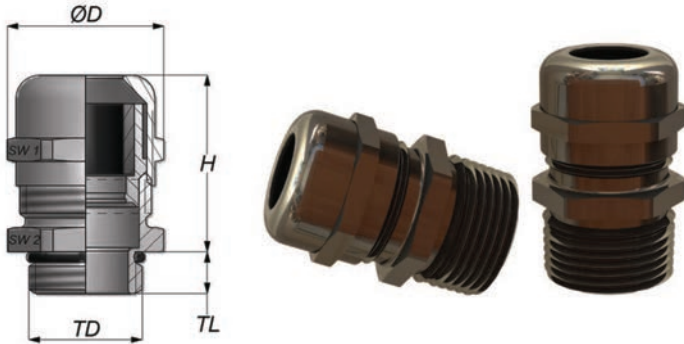

Technical details:

Material:	Brass, Nickel Plated
Clamping Insert:	Polyamide 6
Seal:	Chloroprene (CR)
O-Ring:	Neoprene (NBR)
Protection Class:	IP 68 - 5 Bar
Temperature range	
<i>permanent:</i>	-20°C to +100°C
<i>intermittent:</i>	-40°C to +150°C
Flammability:	V2 (according to UL 94)
Approvals:	cURus, cULus, VDE, DNV-GL, CE

Part Number	Thread Type	Clamping Range Ø min-max		Thread Diameter (TD)		Wrenching Flats Cap (SW1)		Thread Length (TL)	Height (H)	UL
		inches	mm	inches	mm	inches	mm			
Metric										
MMS-12	M12x1.5	.118 - .256	3.0 - 6.5	0.472	12	0.551	14	0.236	0.866	UR
MMS-16*	M16x1.5	.157 - .315	4.0 - 8.0	0.630	16	0.669	17	0.276	0.906	UR
MMS-20*	M20x1.5	.236 - .472	6.0 - 12.0	0.787	20	0.866	22	0.315	1.043	UL
MMS-25*	M25x1.5	.394 - .551	10.0 - 14.0	0.984	25	0.945	24	0.315	1.091	UL
MMS-32	M32x1.5	.512 - .709	13.0 - 18.0	1.260	32	1.181	30	0.354	1.299	UL
MMS-32C	M32x1.5	.709 - .984	18.0 - 25.0	1.260	32	1.575	40	0.354	1.732	UL
MMS-40*	M40x1.5	.709 - .984	18.0 - 25.0	1.575	40	1.575	40	0.354	1.496	UL
MMS-50	M50x1.5	.866 - 1.260	22.0 - 32.0	1.969	50	1.969	50	0.354	1.890	UL
MMS-50C	M50x1.5	1.063 - 1.732	27.0 - 44.0	1.969	50	2.520	64	0.354	2.079	UL
MMS-63	M63x1.5	1.339 - 1.732	34.0 - 44.0	2.480	63	2.520	64	0.551	2.087	UL
MMS-63C	M63x1.5	1.457 - 2.087	37.0 - 53.0	2.480	63	2.953	75	0.394	1.969	-
Metric with Long Thread										
MMS-12L	M12x1.5	.118 - .256	3.0 - 6.5	0.472	12	0.551	14	0.472	0.866	-
MMS-16L*	M16x1.5	.157 - .315	4.0 - 8.0	0.630	16	0.669	17	0.472	0.906	-
MMS-20L*	M20x1.5	.236 - .472	6.0 - 12.0	0.787	20	0.866	22	0.472	1.043	-
MMS-25L*	M25x1.5	.394 - .551	10.0 - 14.0	0.984	25	0.945	24	0.472	1.091	-
MMS-32L*	M32x1.5	.512 - .709	13.0 - 18.0	1.260	32	1.181	30	0.591	1.299	-
MMS-40L*	M40x1.5	.709 - .984	18.0 - 25.0	1.575	40	1.575	40	0.591	1.496	-
MMS-50L	M50x1.5	.866 - 1.260	22.0 - 32.0	1.969	50	1.969	50	0.591	1.890	-
MMS-50CL	M50x1.5	1.063 - 1.732	27.0 - 44.0	1.969	50	2.520	64	0.591	2.079	-
MMS-63L	M63x1.5	1.339 - 1.732	34.0 - 44.0	2.480	63	2.520	64	0.709	2.087	-
MMS-63CL	M63x1.5	1.457 - 2.087	37.0 - 53.0	2.480	63	2.953	75	0.709	1.969	-

*2nd Clamping Range Available

Larger thread sizes (M72 to M120) available upon request

CG 300 PG & NPT METAL CABLE GLANDS

PG & NPT THREAD

Impact resistant, suitable for industrial applications, water tight, corrosion resistant.

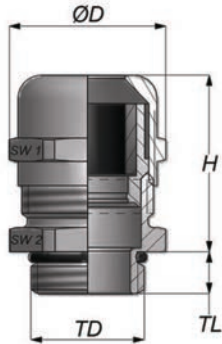

Technical details:

Material:	Brass, Nickel Plated
Clamping Insert:	Polyamide 6
Seal:	Chloroprene (CR)
O-Ring:	Neoprene (NBR)
Protection Class:	IP 68 - 5 Bar
Temperature range	
<i>permanent:</i>	-20°C to +100°C
<i>intermittent:</i>	-40°C to +150°C
Flammability:	V2 (according to UL 94)
Approvals:	cURus, cULus, DNV-GL, CE

Part Number	Thread Type	Clamping Range Ø min-max		Thread Diameter (TD)		Wrenching Flats Cap (SW1)		Thread Length (TL)	Height (H)	UL
		inches	mm	inches	mm	inches	mm			
PG										
MPS-7	PG 7	.118 - .256	3.0 - 6.5	0.492	12.5	0.551	14	0.236	0.866	UR
MPS-9	PG 9	.157 - .315	4.0 - 8.0	0.598	15.2	0.669	17	0.236	0.925	UR
MPS-11	PG 11	.197 - .394	5.0 - 10.0	0.732	18.6	0.787	20	0.236	1.024	UR
MPS-13	PG 13.5	.236 - .472	6.0 - 12.0	0.803	20.4	0.866	22	0.256	0.965	UR
MPS-16	PG 16	.394 - .551	10.0 - 14.0	0.886	22.5	0.945	24	0.256	1.102	UL
MPS-21	PG 21	.512 - .709	13.0 - 18.0	1.114	28.3	1.181	30	0.283	1.280	UL
MPS-29	PG 29	.709 - .984	18.0 - 25.0	1.457	37.0	1.575	40	0.315	1.516	UL
MPS-36	PG 36	.866 - 1.260	22.0 - 32.0	1.850	47.0	1.969	50	0.354	1.890	UL
MPS-42	PG 42	1.182 - 1.496	30.0 - 38.0	2.126	54.0	2.283	58	0.472	1.909	UL
MPS-48	PG 48	1.339 - 1.732	34.0 - 44.0	2.335	59.3	2.520	64	0.551	2.087	UL
PG with Long Thread										
MPS-7L	PG 7	.118 - .256	3.0 - 6.5	0.492	12.5	0.551	14	0.394	0.866	UR
MPS-9L	PG 9	.157 - .315	4.0 - 8.0	0.598	15.2	0.669	17	0.394	0.925	UR
MPS-11L	PG 11	.197 - .394	5.0 - 10.0	0.732	18.6	0.787	20	0.394	1.024	UR
MPS-13L	PG 13.5	.236 - .472	6.0 - 12.0	0.803	20.4	0.866	22	0.394	0.965	UR
MPS-16L	PG 16	.394 - .551	10.0 - 14.0	0.886	22.5	0.945	24	0.394	1.102	UL
MPS-21L	PG 21	.512 - .709	13.0 - 18.0	1.114	28.3	1.181	30	0.472	1.280	UL
MPS-29L	PG 29	.709 - .984	18.0 - 25.0	1.457	37.0	1.575	40	0.472	1.516	UL
MPS-36L	PG 36	.866 - 1.260	22.0 - 32.0	1.850	47.0	1.969	50	0.551	1.890	UL
MPS-42L	PG 42	1.182 - 1.496	30.0 - 38.0	2.126	54.0	2.283	58	0.630	1.909	UL
MPS-48L	PG 48	1.339 - 1.732	34.0 - 44.0	2.335	59.3	2.520	64	0.709	2.087	UL
NPT										
MNS-3/8	NPT 3/8	.157 - .315	4.0 - 8.0	0.675	17.1	0.669	17	0.453	0.906	UR
MNS-3/8C	NPT 3/8	.197 - .394	5.0 - 10.0	0.675	17.1	0.787	20	0.453	1.161	-
MNS-1/2	NPT 1/2	.236 - .472	6.0 - 12.0	0.840	21.3	0.866	22	0.512	1.004	UL
MNS-1/2C	NPT 1/2	.394 - .551	10.0 - 14.0	0.840	21.3	0.944	24	0.512	1.102	-
MNS-3/4	NPT 3/4	.512 - .709	13.0 - 18.0	1.050	26.7	1.181	30	0.512	1.398	UL
MNS-1	NPT 1	.709 - .984	18.0 - 25.0	1.315	33.4	1.574	40	0.512	1.693	UL

CG 350 METRIC & PG STAINLESS STEEL CABLE GLANDS

METRIC & PG THREAD

Impact resistant, suitable for industrial and food and beverage applications, water tight, corrosion resistant.

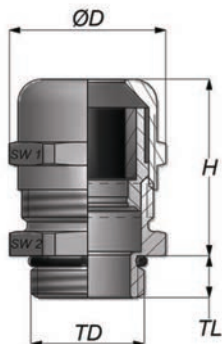

Technical details:

Material:	Stainless steel (AISI 303) or (AISI 316L)
Clamping Insert:	Polyamide 6
Seal:	Chloroprene (CR)
O-Ring:	Neoprene (NBR)
Protection Class:	IP 68 - 5 Bar
Temperature range	
<i>permanent:</i>	-20°C to +100°C
<i>intermittent:</i>	-40°C to +150°C
Flammability:	V2 (according to UL 94)
Approvals:	cURus, cULus, VDE, DNV-GL, CE

Part Number		Thread Type	Clamping Range Ø min-max		Thread Diameter (TD)		Wrenching Flats Cap (SW1)		Thread Length (TL)	Height (H)	UL
SS 303	SS 316		inches	mm	inches	mm	inches	mm			
Metric											
SM3-12	SM6-12	M12x1.5	.118 - .256	3.0 - 6.5	0.472	12.0	0.551	14	6.0	22.0	UR
SM3-16	SM6-16	M16x1.5	.157 - .315	4.0 - 8.0	0.630	16.0	0.669	17	7.0	23.0	-
SM3-20	SM6-20	M20x1.5	.236 - .473	6.0 - 12.0	0.787	20.0	0.866	22	8.0	24.0	UL
SM3-25	SM6-25	M25x1.5	.394 - .551	10.0 - 14.0	0.984	25.0	0.945	24	8.0	27.5	-
SM3-32	SM6-32	M32x1.5	.512 - .709	13.0 - 18.0	1.260	32.0	1.181	30	9.0	32.5	-
SM3-40	SM6-40	M40x1.5	.709 - .984	18.0 - 25.0	1.575	40.0	1.614	41	9.0	40.6	-
SM3-50	SM6-50	M50x1.5	.866 - 1.260	22.0 - 32.0	1.969	50.0	1.969	50	9.0	46.0	-
SM3-63	SM6-63	M63x1.5	1.339 - 1.732	34.0 - 44.0	2.480	63.0	2.559	65	14.0	53.0	UL
PG¹											
SP3-7	SP6-7	PG 7	.118 - .256	3.0 - 6.5	0.492	12.5	0.551	14	6.0	22.0	-
SP3-9	SP6-9	PG 9	.157 - .315	4.0 - 8.0	0.598	15.2	0.669	17	6.0	23.0	-
SP3-11	SP6-11	PG 11	.197 - .394	5.0 - 10.0	0.732	18.6	0.866	22	6.0	25.5	-
SP3-13	SP6-13	PG 13.5	.236 - .472	6.0 - 12.0	0.803	20.4	0.866	22	6.5	24.0	-
SP3-16	SP6-16	PG 16	.394 - .551	10.0 - 14.0	0.886	22.5	0.945	24	6.5	27.5	-
SP3-21	SP6-21	PG 21	.512 - .709	13.0 - 18.0	1.114	28.3	1.181	30	7.2	32.5	-
SP3-29	SP6-29	PG 29	.709 - .984	18.0 - 25.0	1.457	37.0	1.614	41	8.0	38.5	-
SP3-36	SP6-36	PG 36	.866 - 1.261	22.0 - 32.0	1.850	47.0	1.969	50	9.0	46.0	-
SP3-42	SP6-42	PG 42	1.181 - 1.496	30.0 - 38.0	2.126	54.0	2.362	60	12.0	48.0	-
SP3-48	SP6-48	PG 48	1.339 - 1.732	34.0 - 44.0	2.335	59.3	2.559	65	14.0	49.5	-

¹PG is not VDE approved
Stainless steel locknut available upon request

EMC CABLE GLANDS

EMC-2 AND EMC-4

The EMC cable glands combine several advantages into one product. With the EMC gland, you get the same clamping range as a normal brass gland with a protection class of IP 68 and the added feature of EMC grounding springs to quickly ground a shielded cable to a metal enclosure or motor. To create the ground path, remove 5-10mm of the jacket to expose the braid and position the gland on the cable. The large surface of the fingers come in contact with the braid to provide a completed grounding connection. Furthermore, the EMC design will give you a low impedance electrical contact between the body and the cable braid without having to open the gland. The shielding for electromagnetic purposes will be perfect by just tightening the gland delivered in a ready to use assembly.

EMC-2



- ▶ Optimal grounding of shielded cable
- ▶ One direction installation
- ▶ Impact resistant
- ▶ Suitable for the highest demands of today's technology
- ▶ Easy installation
- ▶ Easy handling
- ▶ High corrosion resistance
- ▶ Water tight
- ▶ Strain relief

EMC-4



- ▶ Optimal grounding of shielded cable
- ▶ Bi-directional installation
- ▶ Impact resistant
- ▶ Free radial and axial movement of the cable without any damage to the braid
- ▶ Easy installation
- ▶ Large contact surface of the fingers allowing low contact resistance
- ▶ High contact performance under vibrating conditions
- ▶ Water tight
- ▶ Strain relief



CG EMC-2 METRIC GROUNDING CABLE GLANDS

METRIC THREAD

Optimal grounding of shielded cable, easy installation, water tight, impact resistant.

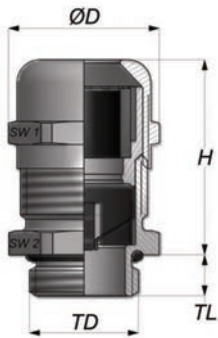

Technical details:

Material:	Brass, Nickel Plated
Contact Spring:	Special Copper Alloy
Clamping Insert:	Polyamide 6
Seal:	Chloroprene (CR)
O-Ring:	Neoprene (NBR)
Protection Class:	IP 68 - 5 Bar
Temperature range	
<i>permanent:</i>	-20°C to +100°C
<i>intermittent:</i>	-40°C to +150°C
Flammability:	V2 (according to UL 94)
Approvals:	DNV-GL, CE

Part Number	Thread Type	Clamping Range Ø min-max		Shield Diameter (Ø min)		Wrenching Flats Cap (SW1)		Thread Diameter (TD)	Thread Length (TL)	Height (H)
		inches	mm	inches	mm	inches	mm			
Metric										
EM2-12	M12x1.5	.118 - .256	3.0 - 6.5	0.098	2.5	0.551	14	12	6	22.0
EM2-16	M16x1.5	.158 - .315	4.0 - 8.0	0.118	3.0	0.669	17	16	7	23.0
EM2-16C	M16x1.5	.177 - .394	4.5 - 10.0	0.138	3.5	0.787	20	16	6.5	29.0
EM2-20	M20x1.5	.236 - .472	6.0 - 12.0	0.177	4.5	0.866	22	20	8	24.5
EM2-25	M25x1.5	.394 - .551	10.0 - 14.0	0.335	8.5	0.945	24	25	8	28.0
EM2-25C	M25x1.5	.512 - .709	13.0 - 18.0	0.413	10.5	1.181	30	25	8	37.5
EM2-32	M32x1.5	.512 - .709	13.0 - 18.0	0.433	11.0	1.181	30	32	9	32.5
EM2-32C	M32x1.5	.709 - .984	18.0 - 25.0	0.551	14.0	1.575	40	32	9	44.0
EM2-40	M40x1.5	.709 - .984	18.0 - 25.0	0.630	16.0	1.575	40	40	9	38.0
EM2-40C	M40x1.5	.866 - 1.261	22.0 - 32.0	0.787	20.0	1.969	50	40	9	52.5
EM2-50	M50x1.5	.866 - 1.261	22.0 - 32.0	0.787	20.0	1.969	50	50	9	48.0
EM2-50C	M50x1.5	1.063 - 1.734	27.0 - 44.0	1.024	26.0	2.520	64	50	9	54.0
EM2-63	M63x1.5	1.340 - 1.734	34.0 - 44.0	1.220	31.0	2.520	64	63	14	53.0
Metric with Long Thread										
EM2-12L	M12x1.5	.118 - .256	3.0 - 6.5	0.098	2.5	0.551	14	12	12	22.0
EM2-16L	M16x1.5	.158 - .315	4.0 - 8.0	0.118	3.0	0.669	17	16	12	23.0
EM2-20L	M20x1.5	.236 - .472	6.0 - 12.0	0.177	4.5	0.866	22	20	12	24.5
EM2-25L	M25x1.5	.394 - .551	10.0 - 14.0	0.335	8.5	0.945	24	25	12	28.0
EM2-32L	M32x1.5	.512 - .709	13.0 - 18.0	0.433	11.0	1.181	30	32	15	32.5
EM2-40L	M40x1.5	.709 - .984	18.0 - 25.0	0.630	16.0	1.575	40	40	15	38.0
EM2-50L	M50x1.5	.866 - 1.261	22.0 - 32.0	0.787	20.0	1.969	50	50	15	48.0
EM2-63L	M63x1.5	1.340 - 1.734	34.0 - 44.0	1.220	31.0	2.520	64	63	18	53.0

CG EMC-2 PG & NPT GROUNDING CABLE GLANDS

PG & NPT THREAD

Optimal grounding of shielded cable, easy installation, water tight, impact resistant.

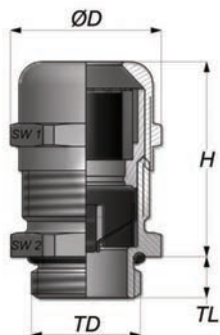

Technical details:

Material:	Brass, Nickel Plated
Contact Spring:	Special Copper Alloy
Clamping Insert:	Polyamide 6
Seal:	Chloroprene (CR)
O-Ring:	Neoprene (NBR)
Protection Class:	IP 68 - 5 Bar
Temperature range	
<i>permanent:</i>	-20°C to +100°C
<i>intermittent:</i>	-40°C to +150°C
Flammability:	V2 (according to UL 94)
Approvals:	cURus, cULus, DNV-GL, CE

Part Number	Thread Type	Clamping Range Ø min-max		Shield Diameter (Ø min)		Wrenching Flats Cap (SW1)		Thread Diameter (TD)	Thread Length (TL)	Height (H)	UL
		inches	mm	inches	mm	inches	mm				
PG¹											
EP2-7	PG 7	.118 - .256	3.0 - 6.5	0.098	2.5	0.551	14	12.5	6.0	22.0	-
EP2-9	PG 9	.157 - .315	4.0 - 8.0	0.118	3.0	0.669	17	15.2	6.0	23.2	-
EP2-11	PG 11	.197 - .394	5.0 - 10.0	0.157	4.0	0.787	20	18.6	6.0	26.0	-
EP2-13	PG 13.5	.236 - .473	6.0 - 12.0	0.197	5.0	0.866	22	20.4	6.5	24.5	-
EP2-16	PG 16	.394 - .551	10.0 - 14.0	0.335	8.5	0.945	24	22.5	6.5	28.0	-
EP2-21	PG 21	.512 - .709	13.0 - 18.0	0.433	11.0	1.181	30	28.3	7.2	32.5	-
EP2-29	PG 29	.709 - .984	18.0 - 25.0	0.630	16.0	1.575	40	37.0	8.0	38.0	-
EP2-36	PG 36	.866 - 1.260	22.0 - 32.0	0.787	20.0	1.969	50	47.0	9.0	48.0	-
EP2-42	PG 42	1.181 - 1.497	30.0 - 38.0	1.102	28.0	2.283	58	54.0	12.0	48.0	-
EP2-48	PG 48	1.339 - 1.732	34.0 - 44.0	1.220	31.0	2.520	64	59.3	14.0	52.4	-
PG with Long Thread¹											
EP2-7L	PG 7	.118 - .256	3.0 - 6.5	0.098	2.5	0.551	14	12.5	8.0	22.0	-
EP2-9L	PG 9	.157 - .315	4.0 - 8.0	0.118	3.0	0.669	17	15.2	10.0	23.2	-
EP2-11L	PG 11	.197 - .394	5.0 - 10.0	0.157	4.0	0.787	20	18.6	10.0	26.0	-
EP2-13L	PG 13.5	.236 - .473	6.0 - 12.0	0.197	5.0	0.866	22	20.4	10.0	24.5	-
EP2-16L	PG 16	.394 - .551	10.0 - 14.0	0.335	8.5	0.945	24	22.5	10.0	28.0	-
EP2-21L	PG 21	.512 - .709	13.0 - 18.0	0.433	11.0	1.181	30	28.3	12.0	32.5	-
EP2-29L	PG 29	.709 - .984	18.0 - 25.0	0.630	16.0	1.575	40	37.0	12.0	38.0	-
EP2-36L	PG 36	.866 - 1.260	22.0 - 32.0	0.787	20.0	1.969	50	47.0	14.0	48.0	-
EP2-42L	PG 42	1.181 - 1.497	30.0 - 38.0	1.102	28.0	2.283	58	54.0	16.0	48.0	-
EP2-48L	PG 48	1.339 - 1.732	34.0 - 44.0	1.220	31.0	2.520	64	59.3	18.0	52.4	-
NPT											
EN2-3/8	NPT 3/8	.196 - .394	5.0 - 10.0	0.157	4.0	0.787	20	17.1	11.5	29.5	UR
EN2-1/2	NPT 1/2	.236 - .472	6.0 - 12.0	0.196	5.0	0.866	22	21.3	13.0	25.5	UL
EN2-3/4	NPT 3/4	.512 - .709	13.0 - 18.0	0.433	11.0	1.181	30	26.7	13.0	35.5	UL
EN2-1	NPT 1	.709 - .984	18.0 - 25.0	0.629	16.0	1.574	40	33.4	13.0	43.0	UL

¹ PG is DNV-GL & CE only

CG EMC-4 SERIES GROUNDING CABLE GLANDS

METRIC, PG, & NPT THREAD

Optimal grounding of shielded cable, bi-directional cable installation, impact resistant.

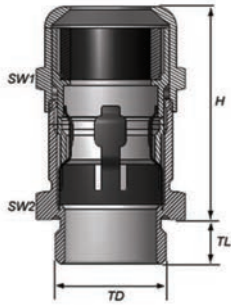

Technical details:

Material:	Brass, Nickel Plated
Contact Spring:	Special Copper Alloy
Clamping Insert:	Polyamide 6
Seal:	Chloroprene (CR)
O-Ring:	Neoprene (NBR)
Protection Class:	IP 68 - 5 Bar
Temperature range	
<i>permanent:</i>	-20°C to +100°C
<i>intermittent:</i>	-40°C to +300°C
Flammability:	V2 (according to UL 94)
Approvals:	cURus, cULus, VDE, DNV-GL, CE

Part Number	Thread Type	Clamping Range Ø min-max		Shield Diameter Ø min-max		Wrenching Flats Cap (SW1)		Thread Diameter (TD)	Thread Length (TL)	Height (H)	UL
		inches	mm	inches	mm	inches	mm				
Metric											
EM4-12	M12x1.5	.118 - .256	3.0 - 6.5	.079 - .197	2.0 - 5.0	0.551	14	12.0	6.0	28.0	UR
EM4-16	M16x1.5	.197 - .394	5.0 - 10.0	.138 - .315	3.5 - 8.0	0.787	20	16.0	6.0	33.0	UR
EM4-20	M20x1.5	.236 - .472	6.0 - 12.0	.177 - .394	4.5 - 10.0	0.866	22	20.0	6.0	32.0	-
EM4-20C	M20x1.5	.295 - .551	7.5 - 14.0	.217 - .453	5.5 - 11.5	0.945	24	20.0	8.0	40.0	UR
EM4-25	M25x1.5	.394 - .709	10.0 - 18.0	.276 - .551	7.0 - 14.0	1.181	30	25.0	8.0	43.0	UR
EM4-32	M32x1.5	.630 - .984	16.0 - 25.0	.472 - .787	12.0 - 20.0	1.575	40	32.0	9.0	53.0	UL
EM4-40	M40x1.5	.866 - 1.260	22.0 - 32.0	.709 - 1.063	18.0 - 27.0	1.969	50	40.0	9.0	60.5	UL
EM4-50	M50x1.5	1.181 - 1.496	30.0 - 38.0	1.024 - 1.339	26.0 - 34.0	2.283	58	50.0	9.0	73.0	UL
EM4-63	M63x1.5	1.339 - 1.732	34.0 - 44.0	1.181 - 1.575	30.0 - 40.0	2.520	64	63.0	14.0	59.0	UL
EM4-63C	M63x1.5	1.457 - 2.087	37.0 - 53.0	1.299 - 1.929	33.0 - 49.0	2.953	75	63.0	10.0	75.0	-
PG¹											
EP4-7	PG 7	.118 - .256	3.0 - 6.5	.079 - .197	2.0 - 5.0	0.551	14	12.5	6.0	28.0	-
EP4-11	PG 11	.197 - .394	5.0 - 10.0	.138 - .315	3.5 - 8.0	0.787	20	18.6	6.0	33.0	-
EP4-13	PG 13.5	.236 - .472	6.0 - 12.0	.177 - .394	4.5 - 10.0	0.866	22	20.4	6.5	31.5	-
EP4-16	PG 16	.295 - .551	7.5 - 14.0	.217 - .453	5.5 - 11.5	0.945	24	22.5	6.5	39.5	-
EP4-21	PG 21	.394 - .709	10.0 - 18.0	.276 - .551	7.0 - 14.0	1.260	32	28.3	7.0	42.5	-
EP4-29	PG 29	.630 - .984	16.0 - 25.0	.472 - .787	12.0 - 20.0	1.575	40	37.0	9.0	52.5	-
EP4-36	PG 36	.866 - 1.260	22.0 - 32.0	.709 - 1.063	18.0 - 27.0	1.969	50	47.0	9.0	60.5	-
EP4-42	PG 42	1.181 - 1.496	30.0 - 38.0	1.024 - 1.339	26.0 - 34.0	2.283	58	54.0	12.0	72.5	-
EP4-48	PG 48	1.339 - 1.732	34.0 - 44.0	1.181 - 1.575	30.0 - 40.0	2.520	64	59.3	14.0	58.5	-
NPT¹											
EN4-1/4	NPT 1/4	.118 - .256	3.0 - 6.5	.079 - .197	2.0 - 5.0	0.551	14	13.7	6.0	28.0	-
EN4-3/8	NPT 3/8	.197 - .394	5.0 - 10.0	.138 - .315	3.5 - 8.0	0.787	20	17.1	6.0	33.0	-
EN4-1/2	NPT 1/2	.236 - .472	6.0 - 12.0	.177 - .394	4.5 - 10.0	0.866	22	21.3	8.0	37.5	-
EN4-1/2C	NPT 1/2	.295 - .551	7.5 - 14.0	.217 - .453	5.5 - 11.5	0.945	24	21.3	8.0	39.5	-
EN4-3/4	NPT 3/4	.394 - .709	10.0 - 18.0	.276 - .551	7.0 - 14.0	1.181	30	26.7	8.0	42.5	-
EN4-1	NPT 1	.630 - .984	16.0 - 25.0	.472 - .787	12.0 - 20.0	1.575	40	33.4	9.0	52.5	-
EN4-1 1/4	NPT 1 1/4	.866 - 1.260	22.0 - 32.0	.709 - 1.063	18.0 - 27.0	1.969	50	42.2	9.0	62.0	-
EN4-1 1/2	NPT 1 1/2	1.181 - 1.496	30.0 - 38.0	1.024 - 1.339	26.0 - 34.0	2.283	58	48.3	9.0	72.0	-
EN4-2	NPT 2	1.339 - 1.732	34.0 - 44.0	1.181 - 1.575	30.0 - 40.0	2.519	68	60.3	14.0	71.5	-

¹ PG & NPT DNV-GL & CE only

METAL & EMC LOCKNUTS

METRIC, PG & NPT THREAD

EMC locknut has grounding teeth to make connection to metal panels or control boxes.

Technical details:

Material:

Brass, Nickel Plated

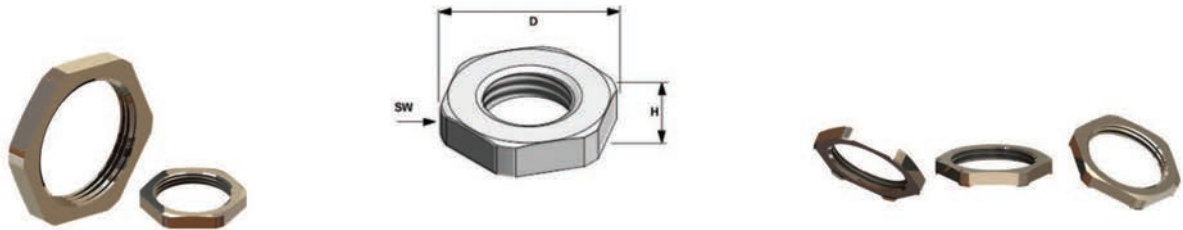

Part Number	Thread Type	Height (H) mm	Diameter (D) mm	Wrenching Flats (SW) mm
Metric-Standard				
LMM-12	M12x1.5	2.8	16.6	15
LMM-16	M16x1.5	3.0	21.0	19
LMM-20	M20x1.5	3.5	26.5	24
LMM-25	M25x1.5	4.0	33.0	30
LMM-32	M32x1.5	5.0	39.5	36
LMM-40	M40x1.5	5.0	51.0	46
LMM-50	M50x1.5	5.0	66.0	60
LMM-63	M63x1.5	6.0	77.0	70
LMM-72	M72x2.0	7.0	86.0	77
LMM-75	M75x2.0	7.0	89.6	80
LMM-80	M80x2.0	8.0	100.0	90
LMM-85	M85x2.0	8.0	106.2	95
LMM-90	M90x2.0	8.0	112.0	100
PG-Standard				
LPM-7	PG 7	2.8	16.6	15
LPM-9	PG 9	2.8	20.0	18
LPM-11	PG 11	3.0	23.5	21
LPM-13	PG 13.5	3.0	25.5	23
LPM-16	PG 16	3.0	29.0	26
LPM-21	PG 21	3.5	35.5	32
LPM-29	PG 29	4.0	45.0	41
LPM-36	PG 36	5.0	56.0	51
LPM-42	PG 42	5.0	66.0	60
LPM-48	PG 48	5.5	70.5	64
NPT-Standard				
LNM-3/8	NPT 3/8	5.0	24.5	22
LNM-1/2	NPT 1/2	5.0	30.0	27
LNM-3/4	NPT 3/4	5.0	36.5	33
LNM-1	NPT 1	5.0	46.5	43

Stainless steel locknuts are available upon request

Part Number	Thread Type	Height (H) mm	Diameter (D) mm	Wrenching Flats (SW) mm
Metric-EMC				
LME-12	M12x1.5	3.3	16.5	15
LME-16	M16x1.5	3.5	21.0	19
LME-20	M20x1.5	3.5	26.5	24
LME-25	M25x1.5	3.5	33.0	30
LME-32	M32x1.5	4.0	39.5	36
LME-40	M40x1.5	4.6	51.0	46
LME-50	M50x1.5	5.6	66.0	60
LME-63	M63x1.5	6.7	77.0	70
PG-EMC				
LPE-7	PG 7	3.3	16.6	15
LPE-9	PG 9	3.3	20.0	18
LPE-11	PG 11	3.5	23.5	21
LPE-13	PG 13.5	3.5	25.5	23
LPE-16	PG 16	3.5	29.0	26
LPE-21	PG 21	4.0	35.5	32
LPE-29	PG 29	4.6	45.0	41
LPE-36	PG 36	5.6	56.0	51
LPE-42	PG 42	5.6	66.0	60
LPE-48	PG 48	6.1	70.5	64

Stainless steel locknuts are available upon request

METAL ENLARGERS

METRIC & PG THREAD

Enlargers are ideal when a threaded hole exists and you need to secure a larger thread or different style of thread. Made of nickel plated brass, SAB's enlargers are very durable.

Technical details:

Material: Brass, Nickel Plated
Attachment Thread: EN 60423 (Metric)
 DIN 40430 (PG)

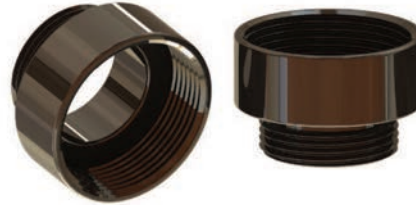

OD	Outer diameter
ID	Inner diameter
OT	Outer thread
IT	Inner thread
OTL	Outer thread length
ITL	Inner thread length
H	Height

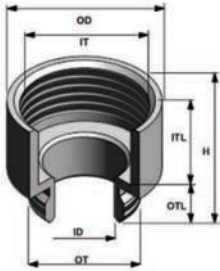

Part Number	Thread Type OT (male)	Thread Type IT (female)	ITL (mm)	OTL (mm)	OD (mm)	ID (mm)
PG-PG						
ENL-01	PG 7	PG 9	5.0	5.0	17.0	8.0
ENL-02	PG 9	PG 11	7.0	6.0	20.0	11.7
ENL-03	PG 9	PG 13.5	9.0	6.0	22.0	11.5
ENL-04	PG 11	PG 13.5	8.5	6.0	22.0	13.8
ENL-05	PG 11	PG 16	8.5	6.5	24.0	13.8
ENL-06	PG 11	PG 21	10.0	6.5	30.0	13.8
ENL-07	PG 13.5	PG 16	8.5	6.5	24.0	16.4
ENL-08	PG 13.5	PG 21	10.0	6.5	30.0	16.5
ENL-09	PG16	PG 21	10.0	6.5	29.7	17.6
ENL-10	PG 16	PG 29	12.0	7.0	40.0	17.5
ENL-11	PG 21	PG 29	14.0	7.0	39.0	24.0
ENL-12	PG 29	PG 36	17.5	8.0	50.0	32.0
ENL-13	PG 36	PG 42	19.0	9.0	57.0	38.0
ENL-14	PG 42	PG 48	19.5	10.0	64.0	49.2
Metric-PG						
ENL-15	M12x1.5	PG 9	7.0	6.0	17.0	8.0
ENL-16	M16x1.5	PG 11	7.5	6.0	20.0	12.0
ENL-17	M20x1.5	PG 16	8.5	8.0	24.0	16.0
ENL-18	M25x1.5	PG 21	10.0	9.0	30.0	20.5
ENL-19	M32x1.5	PG 29	13.0	8.0	40.0	27.5
ENL-20	M40x1.5	PG 36	14.0	9.0	50.0	35.5
ENL-21	M50x1.5	PG 42	18.0	9.0	57.0	45.5
ENL-22	M63x1.5	PG 48	18.0	9.0	64.0	56.0
Metric-Metric						
ENL-23	M12x1.5	M16x1.5	7.0	6.0	18.0	8.0
ENL-24	M16x1.5	M20x1.5	10.0	6.0	22.0	12.0
ENL-25	M20x1.5	M25x1.5	8.5	7.0	27.0	16.0
ENL-26	M25x1.5	M32x1.5	9.5	8.0	34.0	20.5
ENL-27	M32x1.5	M40x1.5	8.5	8.0	42.0	26.0
ENL-28	M40x1.5	M50x1.5	15.0	8.0	52.0	35.5
ENL-29	M50x1.5	M63x1.5	9.5	9.0	65.0	45.0

METAL REDUCERS

METRIC & PG THREAD

Reducers are ideal when a threaded hole exists and you need to secure a smaller thread or different style of thread. Made of nickel plated brass, SAB's reducers are very durable.

Technical details:

Material: Brass, Nickel Plated
Attachment Thread: EN 60423 (Metric)
 DIN 40430 (PG)

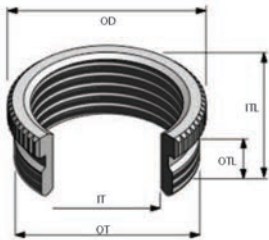

OD	Outer diameter
OT	Outer thread
IT	Inner thread
OTL	Outer thread length
ITL	Inner thread length

Part Number	Thread Type OT (male)	Thread Type IT (female)	ITL (mm)	OTL (mm)	OD (mm)
PG-PG					
RED-01	PG 9	PG 7	8.5	6.0	17.0
RED-02	PG 11	PG 7	9.0	6.0	20.0
RED-03	PG 11	PG 9	9.0	6.0	20.0
RED-04	PG 13.5	PG 7	9.0	6.5	22.0
RED-05	PG 13.5	PG 9	9.0	6.5	22.0
RED-06	PG 13.5	PG 11	9.0	6.5	22.0
RED-07	PG 16	PG 7	9.5	6.5	24.0
RED-08	PG 16	PG 9	9.5	6.5	24.0
RED-09	PG 16	PG 11	9.0	6.0	24.0
RED-10	PG 16	PG 13.5	9.0	6.0	24.0
RED-11	PG 21	PG 11	10.0	7.0	30.0
RED-12	PG 21	PG 13.5	10.0	7.0	30.0
RED-13	PG 21	PG 16	10.0	7.0	30.0
RED-14	PG 29	PG 13.5	11.5	8.0	39.0
RED-15	PG 29	PG 16	11.5	8.0	39.0
RED-16	PG 29	PG 21	11.4	8.0	39.0
RED-17	PG 36	PG 21	12.4	9.0	50.0
RED-18	PG 36	PG 29	12.5	9.1	50.0
RED-19	PG 42	PG 29	14.0	10.0	57.0
RED-20	PG 42	PG 36	14.1	10.0	57.0
RED-21	PG 48	PG 36	14.0	10.0	64.0
RED-22	PG 48	PG 42	14.0	10.0	64.0
PG-Metric					
RED-23	PG 16	M20x1.5	9.0	6.0	24.0
RED-24	PG 21	M20x1.5	10.0	7.0	30.0
RED-25	PG 21	M25x1.5	10.0	7.0	30.0
RED-26	PG 29	M25x1.5	11.5	8.0	39.0
Metric-Metric					
RED-27	M16x1.5	M12x1.5	9.5	6.5	18.0
RED-28	M20x1.5	M12x1.5	9.5	6.5	22.0
RED-29	M20x1.5	M16x1.5	9.0	6.5	22.0
RED-30	M25x1.5	M16x1.5	9.0	6.5	28.0
RED-31	M25x1.5	M20x1.5	11.5	8.0	30.0
RED-32	M32x1.5	M20x1.5	11.5	8.0	39.0
RED-33	M32x1.5	M25x1.5	11.5	8.0	39.0
RED-34	M40x1.5	M25x1.5	12.5	9.0	50.0
RED-35	M40x1.5	M32x1.5	12.5	9.0	50.0
RED-36	M50x1.5	M32x1.5	14.0	10.0	64.0
RED-37	M50x1.5	Mx401.5	14.0	10.0	64.0
RED-38	M63x1.5	M40x1.5	18.0	10.0	71.6
RED-39	M63x1.5	M50x1.5	18.0	10.0	71.6

MULTI-HOLE BUSHINGS

METRIC, PG & NPT THREAD

Multi-hole bushings are ideal for when there is limited space on a control cabinet or when you have multiple smaller cables that need to be secured. They are made of black neoprene and, when used with a SAB cord grip, will provide an excellent seal.

Technical details:

Material: Neoprene (NBR)
Color: Black



Part Number	PG	Thread Type		Hole Quantity	Hole Diameter Ø mm	Outside Diameter Ø mm	Thickness (mm)
		Metric	NPT				
MHB-01	PG 9	—	—	2	4.0	10.9	7.0
MHB-02	PG 9	—	—	2	3.0	10.9	7.0
MHB-03	PG 9	—	—	4	3.0	10.9	7.0
MHB-04	PG 11	M16	3/8"	2	4.0	13.7	10.4
MHB-05	PG 11	M16	3/8"	2	4.5	13.7	10.4
MHB-06	PG 11	M16	3/8"	2	2.0	13.7	10.4
MHB-07	PG 11	M16	3/8"	2	3.0	13.7	10.4
MHB-08	PG 11	M16	3/8"	2	5.0	13.7	10.4
MHB-09	PG 11	M16	3/8"	3	4.0	13.7	10.4
MHB-10	PG 13.5	M20	1/2"	2	6.0	16.0	8.4
MHB-11	PG 13.5	M20	1/2"	3	4.0	16.0	8.4
MHB-12	PG 13.5	M20	1/2"	3	5.0	16.0	8.4
MHB-13	PG 13.5	M20	1/2"	4	3.0	16.0	8.4
MHB-14	PG 13.5	M20	1/2"	2	5.0	16.0	8.4
MHB-15	PG 13.5	M20	1/2"	4	4.0	16.0	8.4
MHB-16	PG 16	M20C	1/2"C	2	6.0	18.0	9.3
MHB-17	PG 16	M20C	1/2"C	2	7.0	18.0	9.3
MHB-18	PG 16	M20C	1/2"C	3	4.0	18.0	9.3
MHB-19	PG 16	M20C	1/2"C	2	4.0	18.0	9.3
MHB-20	PG 16	M20C	1/2"C	4	5.0	18.0	9.3
MHB-23	PG 16	M20C	1/2"C	5	4.0	18.0	9.3
MHB-24	PG 21	M25	3/4"	2	6.0	22.9	12.2
MHB-25	PG 21	M25	3/4"	2	6.6	22.9	12.2
MHB-26	PG 21	M25	3/4"	2	7.0	22.9	12.2
MHB-27	PG 21	M25	3/4"	2	8.0	22.9	12.2
MHB-28	PG 21	M25	3/4"	2	9.0	22.9	12.2
MHB-29	PG 21	M25	3/4"	3	6.6	22.9	12.2
MHB-30	PG 21	M25	3/4"	3	8.0	22.9	12.2
MHB-31	PG 21	M25	3/4"	4	6.0	22.9	12.2
MHB-32	PG 21	M25	3/4"	4	6.6	22.9	12.2
MHB-33	PG 21	M25	3/4"	4	7.0	22.9	12.2
MHB-34	PG 21	M25	3/4"	8	1.5	22.9	12.2
MHB-43	PG 29	M32	1"	2	8.0	30.4	14.0
MHB-44	PG 29	M32	1"	2	9.0	30.4	14.0
MHB-45	PG 29	M32	1"	3	7.5	30.4	14.0
MHB-46	PG 29	M32	1"	3	8.0	30.4	14.0
MHB-47	PG 29	M32	1"	4	8.0	30.4	14.0
MHB-48	PG 29	M32	1"	5	8.5	30.4	14.0
MHB-49	PG 29	M32	1"	6	6.0	30.4	14.0
MHB-50	PG 29	M32	1"	6	7.5	30.4	14.0
MHB-51	PG 29	M32	1"	6	5.0	30.4	14.0

ROUND & HEX HOLE PLUGS

METRIC & PG THREAD

Hole plugs are used where a pre-existing threaded hole exists with no cable that needs to be closed and protected. SAB offers a round and hex top Polyamide 6 product in gray or black & PG and metric thread.

Technical details:

Material:	Polyamide 6
Flammability:	V2 (according to UL 94)
Temperature range	
<i>permanent:</i>	-20°C to +100°C
<i>intermittent:</i>	-30°C to +150°C

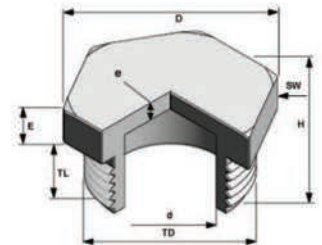
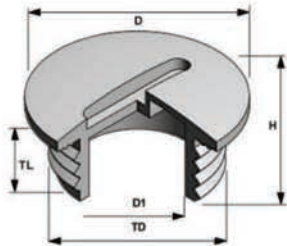

Part Number		Thread Type	Plug Diameter (TD)		Thread Length (TL)		Overall Height (H)		
Gray	Black		inches	mm	inches	mm	inches	mm	
Metric: Round									
HPR-17	HPR-24	M12x1.5	0.591	15	0.236	6	0.413	10.5	
HPR-18	HPR-25	M16x1.5	0.787	20	0.276	7	0.453	11.5	
HPR-19	HPR-26	M20x1.5	0.945	24	0.276	7	0.492	12.5	
HPR-20	HPR-27	M25x1.5	1.181	30	0.394	10	0.591	15.0	
HPR-21	HPR-28	M32x1.5	1.457	37	0.315	8	0.551	14.0	
HPR-22	HPR-29	M40x1.5	1.811	46	0.236	6	0.492	12.5	
HPR-23	HPR-30	M50x1.5	2.205	56	0.394	10	0.551	14.0	
PG: Round									
HPR-01	HPR-09	PG 7	0.591	15	0.236	6	0.315	8.0	
HPR-02	HPR-10	PG 9	0.748	19	0.236	6	0.335	8.5	
HPR-03	HPR-11	PG 11	0.866	22	0.236	6	0.335	8.5	
HPR-04	HPR-12	PG 13.5	0.984	25	0.236	6	0.335	8.5	
HPR-05	HPR-13	PG 16	1.063	27	0.236	6	0.354	9.0	
HPR-06	HPR-14	PG 21	1.299	33	0.315	8	0.472	12.0	
HPR-07	HPR-15	PG 29	1.732	44	0.315	8	0.453	11.5	
HPR-08	HPR-16	PG 36	2.165	55	0.394	10	0.551	14.0	

Part Number		Thread Type	Plug Diameter (TD)		Thread Length (TL)		Wrenching Flat (SW)		Overall Height (H)	
Gray	Black		inches	mm	inches	mm	inches	mm	inches	mm
Metric: Hex										
HPH-01	HPH-13	M12x1.5	0.669	17.0	0.394	10.0	0.591	15	0.591	15.0
HPH-02	HPH-14	M16x1.5	0.866	22.0	0.472	12.0	0.748	19	0.642	16.3
HPH-03	HPH-15	M16x1.5	0.866	22.0	0.591	15.0	0.748	19	0.760	19.3
HPH-04	HPH-16	M20x1.5	1.024	26.0	0.433	11.0	0.906	23	0.669	17.0
HPH-06	HPH-18	M20x1.5	1.024	26.0	0.591	15.0	0.906	23	0.827	21.0
HPH-07	HPH-19	M25x1.5	1.260	32.0	0.394	10.0	1.102	28	0.662	15.8
HPH-08	HPH-20	M25x1.5	1.260	32.0	0.591	15.0	1.102	28	0.819	20.8
HPH-09	HPH-21	M32x1.5	1.634	41.5	0.591	15.0	1.417	36	0.898	22.8
HPH-10	HPH-22	M40x1.5	2.087	53.0	0.709	18.0	1.811	46	1.043	26.5
HPH-11	HPH-23	M50x1.5	2.500	63.5	0.709	18.0	2.165	55	1.083	27.5
HPH-12	HPH-24	M63x1.5	3.150	80.0	0.709	18.0	2.717	69	1.083	27.5

HYGIENIC PRODUCT

CONDUIT FITTING & CABLE GLAND



These fittings are made especially for areas of public health, safety, and protection of the environment. Applications range from the food and beverage industry to the chemical processing industry to cleanrooms because the stainless steel cable fittings and gland boast a smooth surface, with all of the threads beneath the cap nut, preventing the depositing of harmful microorganisms.

The benefits of this range include:

- ▶ Much easier, faster, and less expensive to clean
- ▶ Reduced energy and use of chemicals compared to conventional stainless steel conduit fittings
- ▶ Resistant to high-pressure water jet cleaning (IP 69K)
- ▶ Greater durability because of superior product quality
- ▶ Reliable strain relief due to duplicate cable attachment
- ▶ Chemical resistant
- ▶ Sustains disinfectant, cleaners, and acids or alkalis
- ▶ Suitable for high pressure steam cleaning



CG CLEAN HYGIENIC CABLE GLAND

STANDARD & EMC, METRIC THREAD

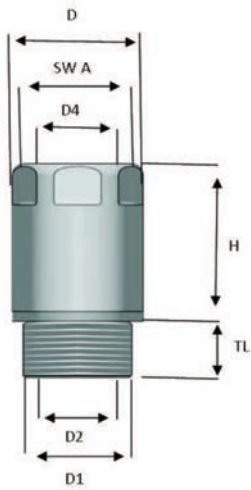

Technical details:

Material:	Stainless steel 1.4404 (AISI 316L)
Seals:	TPE conform to FDA Guideline 21 CFR 177.2600
Clamping Insert:	POM
Protection Categories:	IP 68 (5 bar, 30 min.) acc. to EN 60529 IP 69K to DIN 40050-9
Temperature range <i>permanent:</i>	-20°C to +100°C
<i>intermittent:</i>	-40°C to +150°C
Locknut:	Stainless steel
Approvals:	VDE, DNV-GL, CE

Part Number	Thread Type	Clamping Range Ø min-max		Wrenching Flats (SW A)		Outer Diameter (D)	Thread Diameter (D1)	Thread Length (TL)	Height (H)	Locknut Dimensions (mm)		
		inches	mm	inches	mm					SW	L	e
Metric												
HCGM-12	M12x1.5	.118 - .256	3.0 - 6.5	0.551	14	15.6	12	6	21.5	15	2.8	
HCGM-16	M16x1.5	.197 - .394	5.0 - 10.0	0.709	18	20.2	16	7	23.0	19	3.0	
HCGM-20	M20x1.5	.236 - .472	6.0 - 12.0	0.866	22	24.1	20	10	27.0	24	3.5	
HCGM-25	M25x1.5	.472 - .669	12.0 - 17.0	1.102	28	30.1	25	14	29.5	30	4.0	
Metric: EMC												
HCGE-16	M16x1.5	.197 - .394	5.0 - 10.0	0.709	18	20.2	16	7	28.5	19	3.0	
HCGE-20	M20x1.5	.236 - .472	6.0 - 12.0	0.866	22	24.1	20	10	33.0	24	3.5	
HCGE-25	M25x1.5	.472 - .669	12.0 - 17.0	1.102	28	30.1	25	14	38.0	30	4.0	

Locknut included

TOOLS FOR INSTALLATION

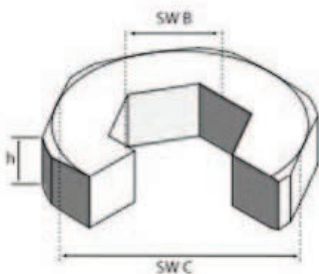

Part Number	Thread Type	Clamping Range Ø min-max		
		SW B	SW C	h
HCGT-01	M12	5	7	5
HCGT-02	M16	6	10	5
HCGT-03	M20	8	13	8
HCGT-04	M25	10	17	8

N
22

E-mail: info@sabcable.com



Web site: www.sabcable.com

CF CLEAN HYGIENIC CONDUIT FITTING METRIC THREAD

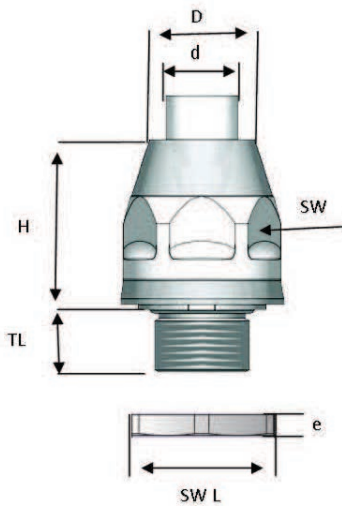

Technical details:

Material:	Stainless steel 1.4404 (AISI 316L)
Seals:	TPE conform to FDA Guideline 21 CFR 177.2600
Ferrule:	Brass, Nickel Plated
Protection Categories:	IP 68 (5 bar, 30 min.) acc. to EN 60529 IP 69K to DIN 40050-9
Temperature range <i>permanent:</i>	-20°C to +100°C
<i>intermittent:</i>	-40°C to +150°C
Locknut:	Stainless steel 1.4305 (AISI 303L)

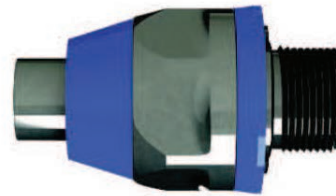

Part Number	Thread Type	Outer Diameter (D)		Inner Diameter (d)		Wrenching Flats (SW A)		Thread Length (TL)	Height (H)	Locknut Dimensions (mm)	
		inches	mm	inches	mm	inches	mm			SW L	e
Metric											
HCFM-16	M16x1.5	0.677	17.2	0.472	12.0	1.063	27	11.5	36.8	19	3.0
HCFM-20	M20x1.5	0.087	20.5	0.591	15.0	1.181	30	13.0	37.3	24	3.5
HCFM-25	M25x1.5	1.016	25.8	0.787	20.0	1.417	36	15.0	42.4	30	4.0
HCFM-32	M32x1.5	1.276	32.4	1.012	25.7	1.811	46	15.0	51.3	36	5.0
HCFM-40	M40x1.5	1.622	41.2	1.346	34.2	2.126	54	16.0	58.9	46	5.0
HCFM-50	M50x1.5	1.846	46.9	1.543	39.2	2.480	63	18.0	63.3	60	5.0
HCFM-63	M63x1.5	2.323	59.0	1.969	50.0	3.031	77	20.0	68.6	70	6.0

Locknut included

TOOLS FOR INSTALLATION



Part Number	Thread Type	Tool Dimension (mm)	
		Ø T	SW T
HCFT-01	M16	24	11
HCFT-02	M20	27	14
HCFT-03	M25	33	19
HCFT-04	M32	42	25
HCFT-05	M40	50	32
HCFT-06	M50	58	36
HCFT-07	M63	72	48

E-mail: info@sabcable.com



Web site: www.sabcable.com

VG VENT PA6 & NPB PLASTIC & METAL VENT GLANDS

METRIC & PG THREAD

Vent glands are used to secure a cable and balance the pressure in an enclosure to protect electronic connections from condensation. They are UL approved and chemical resistant. The vent plugs come in black or gray polyamide or nickel plated brass with different air flow ratings.



Technical details:

Body:	Brass, Nickel Plated or Polyamide 6
Cap:	Brass, Nickel Plated or Polyamide 6
Vent Element:	PTFE
Seal:	Chloroprene (CR)
Washer:	Neoprene (NBR)
Protection Type:	IP 66/67/69K
Temperature range	
<i>permanent:</i>	-20°C to +100°C
<i>intermittent:</i>	-30°C to +150°C
Approvals:	cURus, VDE, DNV-GL, CE

Part Number		Average Air Flow l/h	Water Intrusion Pressure bar	Size	Clamping Range		Thread Length (mm)	Thread Diameter (mm)	Wrenching Flats (mm)	Outer Diameter (mm)	max. Height (mm)
Gray	Black				inches	mm					
Plastic Vent Glands											
VGMG-12	VGMB-12	25	0.1	M12x1.5	.157 - .315	4.0 - 8.0	8.0	12.0	19	21.9	25.5
VGPG-9	VGPB-9	25	0.1	PG 9	.157 - .315	4.0 - 8.0	8.0	15.2	19	21.9	25.5
VGMG-16	VGMB-16	25	0.1	M16x1.5	.157 - .315	4.0 - 8.0	10.0	16.0	19	21.9	25.5
VGPG-11	VGPB-11	25	0.1	PG 11	.157 - .315	4.0 - 8.0	10.0	18.6	19	24.9	24
VGMG-20	VGMB-20	40	0.1	M20x1.5	.236 - .472	6.0 - 12.0	10.0	20.0	24	27.0	30
VGPG-13	VGPB-13	40	0.1	PG 13.5	.236 - .472	6.0 - 12.0	10.0	20.4	24	27.0	30
Metal Vent Glands											
VGMM-12		25	0.1	M12x1.5	.157 - .315	4.0 - 8.0	6.0	12.0	17	18.9	30.5
VGPM-7		25	0.1	PG 7	.157 - .315	4.0 - 8.0	8.0	12.5	17	18.9	30.5
VGPM-9		25	0.1	PG 9	.157 - .315	4.0 - 8.0	6.0	15.2	17	18.9	27.0
VGMM-16		25	0.1	M16x1.5	.157 - .315	4.0 - 8.0	5.0	16.0	17	18.9	27.0
VGMM-16L		35	0.1	M16x1.5	.197 - .394	5.0 - 10.0	8.0	16.0	20	22.0	33.5
VGPM-11		35	0.1	PG 11	.197 - .394	5.0 - 10.0	8.0	18.6	20	22.0	33.5
VGMM-20		50	0.1	M20x1.5	.236 - .472	6.0 - 12.0	8.0	20.0	22	24.5	29.5
VGPM-13		50	0.1	PG 13.5	.236 - .472	6.0 - 12.0	6.5	20.4	22	24.5	29.5

VDE approved for metric threads only

VP VENT PA6 POLYAMIDE VENT PLUGS

METRIC THREAD

Vent plugs are used to balance the pressure in an enclosure to protect electronic connections from condensation. They are UL approved and chemical resistant. The vent plugs come in black or gray polyamide with different air flow ratings.



Technical details:

Body:	Polyamide 6
Cap:	Polyamide 6
Vent Element:	Acrylic Co-Polymer on Nylon Support
Seal:	Chloroprene (CR)
Washer:	Neoprene (NBR)
Protection Type:	IP 66/67/69K
Temperature range	
<i>permanent:</i>	-20°C to +100°C
<i>intermittent:</i>	-30°C to +150°C
Approvals:	cURus, CE

Part Number		Average Air Flow l/h	Water Intrusion Pressure bar	Thread Size	Thread Length (mm)	Thread Diameter (mm)	Hole Diameter (mm)	Outer Diameter (mm)	max. Height (mm)
Gray	Black								
VPG-01	VPB-01	16	0.9	QUICK FIT	7.5	5.5	6.4	17.0	9.3
VPG-02	VPB-02	16	0.9	M12x1.5	6.0	12.0	12.5	18.5	7.6
VPG-02L	VPB-02L	16	0.9	M12x1.5	10.0	12.0	12.5	18.5	7.6
VPG-03	VPB-03	25	0.5	QUICK FIT	7.5	5.5	6.4	17.0	9.3
VPG-04	VPB-04	25	0.5	M12x1.5	6.0	12.0	12.5	18.5	7.6
VPG-04L	VPB-04L	25	0.5	M12x1.5	10.0	12.0	12.5	18.5	7.6
VPG-04H	VPB-04H	42	0.9	M12x1.5	10.0	12.0	12.5	26.0	11.7
VPG-05	VPB-05	42	0.9	M16x1.5	10.0	16.0	16.5	26.0	11.7
VPG-06	VPB-06	42	0.9	M20x1.5	10.0	20.0	20.5	26.0	11.7
VPG-07	VPB-07	120	0.2	QUICK FIT	7.5	5.5	6.4	17.0	9.3
VPG-08H	VPB-08H	120	0.5	M12x1.5	10.0	12.0	12.5	26.0	11.7
VPG-08	VPB-08	120	0.2	M12x1.5	6.0	12.0	12.5	18.5	7.6
VPG-08L	VPB-08L	120	0.2	M12x1.5	10.0	12.0	12.5	18.5	7.6
VPG-09	VPB-09	120	0.5	M16x1.5	10.0	16.0	16.5	26.0	11.7
VPG-10	VPB-10	120	0.5	M20x1.5	10.0	20.0	20.5	26.0	11.7
VPG-11	VPB-11	120	0.9	M40x1.5	18.0	40.0	40.5	55.3	15.5
VPG-12	VPB-12	300	0.1	QUICK FIT	7.5	5.5	6.4	17.0	9.3
VPG-13	VPB-13	300	0.1	M12x1.5	6.0	12.0	12.5	18.5	7.6
VPG-13L	VPB-13L	300	0.1	M12x1.5	10.0	12.0	12.5	18.5	7.6
VPG-14	VPB-14	375	0.5	M40x1.5	18.0	40.0	40.5	55.3	15.5
VPG-15	VPB-15	450	0.2	M12x1.5	10.0	12.0	12.5	26.0	11.7
VPG-16	VPB-16	450	0.2	M16x1.5	10.0	16.0	16.5	26.0	11.7
VPG-17	VPB-17	450	0.2	M20x1.5	10.0	20.0	20.5	26.0	11.7
VPG-18	VPB-18	750	0.1	M12x1.5	10.0	12.0	12.5	26.0	11.7
VPG-19	VPB-19	750	0.1	M16x1.5	10.0	16.0	16.5	26.0	11.7
VPG-20	VPB-20	750	0.1	M20x1.5	10.0	20.0	20.5	26.0	11.7
VPG-21	VPB-21	1350	0.2	M40x1.5	18.0	40.0	40.5	55.3	15.5
VPG-22	VPB-22	2200	0.1	M40x1.5	18.0	40.0	40.5	55.3	15.5

VP VENT NPB METAL VENT PLUGS

METRIC & PG THREAD

Vent plugs are used to balance the pressure in an enclosure to protect electronic connections from condensation. They are UL approved and chemical resistant. The vent plugs are stainless steel AISI 303 and come with different air flow ratings.



Technical details:

Body:	Stainless steel AISI 303
Cap:	Stainless steel AISI 303
Vent Element:	Acrylic Co-Polymer on Nylon Support
Seal:	Chloroprene (CR)
Washer:	Neoprene (NBR)
Protection Type:	IP 66/67/69K
Temperature range	
<i>permanent:</i>	-20°C to +100°C
<i>intermittent:</i>	-30°C to +150°C
Approvals:	cURus

Part Number	Average Air Flow l/h	Water Intrusion Pressure bar	Thread Size	Thread Length (mm)	Thread Diameter (mm)	Outer Diameter (mm)	max. Height (mm)
VPM-01	4	0.9	M4x0.7	3.0	4.0	12.3	2.7
VPM-02	7	0.5	M4x0.7	3.0	4.0	12.3	2.7
VPM-03	16	0.9	M12x1.5	6.0	12.0	18.8	11.0
VPM-03L	16	0.9	M12x1.5	10.0	12.0	18.8	11.0
VPM-04	16	0.9	PG 7	10.5	12.5	18.8	11.0
VPM-05	16	0.9	M16x1.5	6.0	16.0	18.8	12.0
VPM-05H	16	0.9	M16x1.5	6.0	16.0	18.8	16.0
VPM-06	16	0.9	M20x1.5	6.0	20.0	24.5	13.0
VPM-06H	16	0.9	M20x1.5	6.0	20.0	24.5	17.0
VPM-07	25	0.5	M12x1.5	6.0	12.0	18.8	11.0
VPM-07L	25	0.5	M12x1.5	10.0	12.0	18.8	11.0
VPM-08	25	0.5	PG 7	10.5	12.5	18.8	11.0
VPM-09	25	0.5	M16x1.5	6.0	16.0	18.8	12.0
VPM-09L	25	0.5	M16x1.5	6.0	16.0	18.8	16.0
VPM-10	25	0.5	M20x1.5	6.0	20.0	24.5	13.0
VPM-10H	25	0.5	M20x1.5	6.0	20.0	24.5	17.0
VPM-11	35	0.2	M4x0.7	3.0	4.0	12.3	2.7
VPM-12	100	0.1	M4x0.7	3.0	4.0	12.3	2.7
VPM-13	120	0.2	M12x1.5	6.0	12.0	18.8	11.0
VPM-13L	120	0.2	M12x1.5	10.0	12.0	18.8	11.0
VPM-14	120	0.2	PG 7	10.5	12.5	18.8	11.0
VPM-15	120	0.2	M16x1.5	6.0	16.0	18.8	12.0
VPM-15H	120	0.2	M16x1.5	6.0	16.0	18.8	16.0
VPM-16	120	0.2	M20x1.5	6.0	20.0	24.5	13.0
VPM-16H	120	0.2	M20x1.5	6.0	20.0	24.5	17.0
VPM-17	120	0.9	M40x1.5	10.0	40.0	58.0	20.7
VPM-18	300	0.1	M12x1.5	6.0	12.0	18.8	11.0
VPM-18L	300	0.1	M12x1.5	10.0	12.0	18.8	11.0
VPM-19	300	0.1	PG 7	10.5	12.5	18.8	11.0
VPM-20	300	0.1	M16x1.5	6.0	16.0	18.8	12.0
VPM-20H	300	0.1	M16x1.5	6.0	16.0	18.8	16.0
VPM-21	300	0.1	M20x1.5	6.0	20.0	24.5	13.0
VPM-22	375	0.5	M40x1.5	10.0	40.0	58.0	20.7
VPM-23	1350	0.2	M40x1.5	10.0	40.0	58.0	20.7
VPM-24	2200	0.1	M40x1.5	10.0	40.0	58.0	20.7