

400 Hz CABLES

FOR GROUND POWER SUPPORT

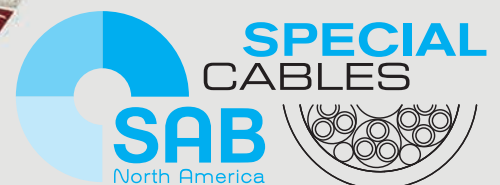

www.sabcable.com
866-722-2974 ■ info@sabcable.com



SAB North America is a focused supplier for the automation, aerospace, medical, high temperature, and robotics industries, providing cable and thermocouple solutions that meet, exceed, and set new standards in the flexible cable market. In addition to flexible cable products, we offer an extensive inventory of high-quality cable accessories, including cord grips, grounding glands and other accessories that complement our flexible control and automation cables.

Whatever the need may be, look to SAB North America for Special Cables that can, for example, help minimize maintenance costs and increase productivity, reduce downtime, and solve specific problems. Here is a small sample of some of the challenges that Special Cables from SAB North America can help address:

- Hybrid designs for multiple functions
- Harsh environments
- Difficult applications
- Industry-specific requirements



Cables deployed in airports, such as those that operate inside boarding bridges, need rugged construction to withstand the rigors of this unique environment. That's why airport operators must be able to count on a single source for wire and cable that also has a deep understanding of airport equipment and infrastructure. SAB North America cables are built to operate reliably in boarding bridges and a host of other airport machines. SAB has more than 75 years of experience manufacturing quality, rugged cables for challenging applications, so you can be sure passengers will be comfortable and operations will run safely and smoothly.

Whether you're a valued distribution partner, a manufacturer, an automation house, an integrator, or a contractor, rest assured that our cables are reliable to maximize production efficiencies. SAB brings world class performance & 75 years of ingenuity to the table.

SAB's level of speed and service as a supplier is unmatched. SAB lives up to its name in not only flexible cable but also flexible manufacturing.



SAB Advantage...We make it Easy

- Engineering & technical assistance
- Cut to length with no cut charges
- Prepaid freight within US for orders over \$2,500
- Specialty cable designs (1500 ft minimum)
- No minimum on orders from stock
- Free drop shipments (no surcharges)
- 24-hour shipments from stock
- Cord Grips for securing and grounding cables

400 Mz Ground Power Cables

... for fixed installation		
■ GP 400 Sy	400 Hz Ground Power Supply Cable - Symmetrical	4
... for flexible application		
■ GP 400 SC	400 Hz Ground Power Supply Cable - SingleCore	5
■ GP 400 QF	400 Hz Ground Power Supply Cable - QuadFlex	6
■ GP 400 7F	400 Hz Ground Power Supply Cable- SevenFlex	7
■ GP 400 SF	400 Hz Ground Power Supply Cable - SymmetricalFlex	8
... for boarding bridges		
■ GP 400 SF S Supply Cable	400 Hz Ground Power Supply Cable, UoU 0.6/1kV	9
■ GP 400 SF S Control Cable	400 Hz Ground Power Control Cable , 300/500V	10
... 28 V DC Cables		
■ GP 400 SC DC	400 Hz Ground Power Supply 28 V DC - SingleCore Direct Current	11
■ GP 400 SF 28V DC	400 Hz Ground Power Supply 28 V DC	12
... Plug'n'Play - ready harnessed with connector		
■ 400 Hz cable for mobile GPUs with connectors		13
■ Ready-to-connect ground power cables with connectors		14

■ Airport equipment:

SAB offers a broad range of cables for airport facilities such as passenger bridges, as well as for continuously flexible applications, wiring cable or for use in bus systems. Our innovative, durable cables stand up to the unique needs of airport equipment and infrastructure.

■ Ground power equipment:

Cables used in ground power units (GPU) and ground support equipment (GSE) must stand up to weather, oils and abrasion. And, changing conditions at runways demand easy connection and installation. Our 400 Hz cables are well-suited for fixed laying, flexible or reeling applications in GPU and GSE systems. These durable cables are also available as plug-and-play devices, harnessed with 400 Hz plugs for different suppliers. One such cable, the GP400 QF power cable with integrated control cores, features flexible, smooth construction for easy handling, plus our SABIX® insulation. It can also be suspended under boarding bridges.



400 Mz Ground Power Cables

GP 400 Sy

400 Hz Ground Power Supply Cable - Symmetrical

for fixed installation

CE EAC RoHS

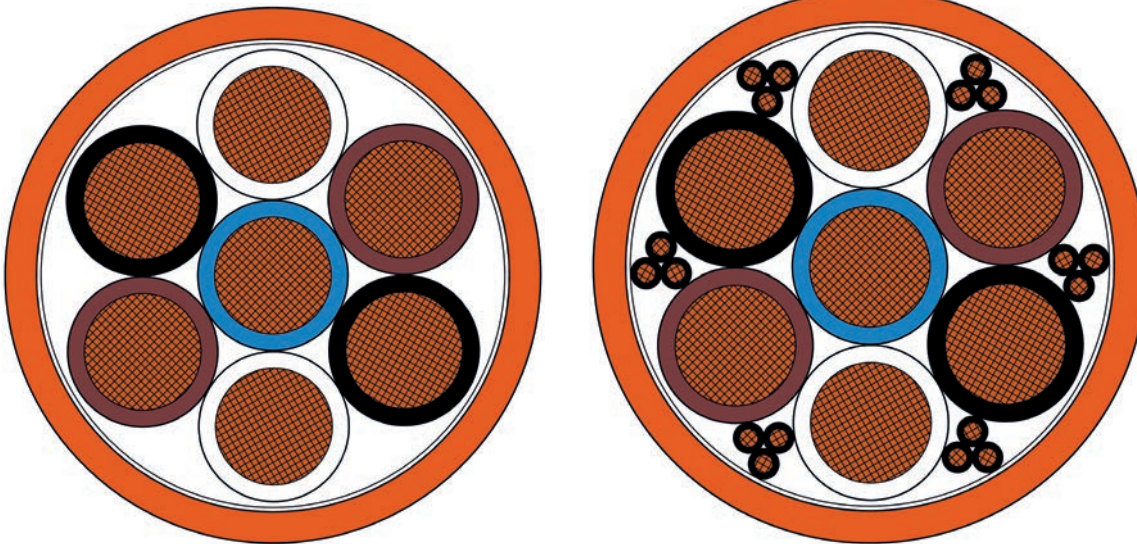

Application: For use as fixed installed cable in 400 Hz systems, e.g. between 400 Hz generator and cable dispenser

Construction:

Conductor:	bare copper strands
Insulation:	2 AWG: PVC 18 AWG: SABIX®
Color code:	control conductors: black with numbers 1 - 18 neutral conductor: blue phase conductor: white, brown, black (two conductors of the same color for the phase)
Stranding:	phase conductors concentrically around the neutral conductor, control conductor as triple in the interstices
Jacket material:	PVC
Jacket color:	orange
Marking:	SAB BRÖCKSKES · D-VIERSEN · GP 400 Sy 7x35.0mm ² +6x3x1.0mm ² 3400-7213 CE and current meter marking

Outstanding features:

- reduced outer diameter

Technical data:

Nominal voltage:	U ₀ /U 0.6/1 kV
Testing voltage:	conductor/conductor: 4000 V AC
Min. bending radius:	
fixed installation:	4 x O.D
flexible application:	8 x O.D
Temperature range:	
static:	-40/+70°C
flexible:	+5/+70°C
Approvals:	CE, EAC, RoHS
Absence of harmful substances:	acc. to RoHS directive of the European Union see page O/30

item no.	AWG/c	outer-ø		cable weight ≈ lbs/mft	DC resistance at 20°C max. Ω/km		voltage drop [mV/(A*m)]
		inch	mm		2 AWG:	18 AWG:	
▶ 34007210	2 AWG / 7c	1.457	37	2018	2 AWG: 0.554	2 AWG: 1.108	
▶ 34007213	2 AWG / 7c + 18 AWG / 6x3	1.457	37	2100	2 AWG: 0.554 18 AWG: 19.500	2 AWG: 1.108 18 AWG: 39.0	

Other dimensions and colors are available on request



Also available with
24 control conductors

400 Mz Ground Power Cables

GP 400 SC

400 Hz Ground Power Supply Cable - SingleCore

for flexible application

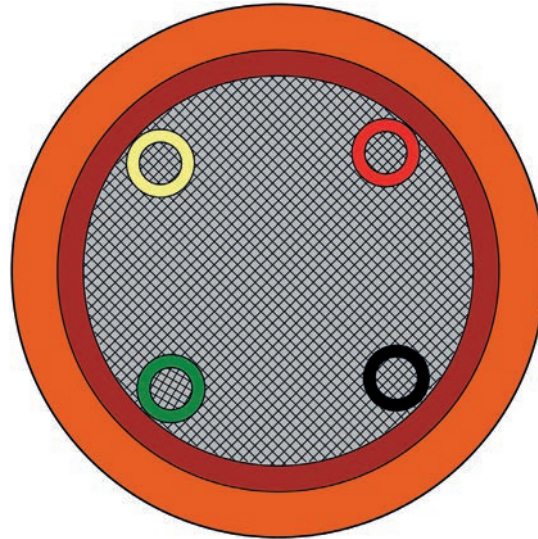

Application: For use in flexible applications, e.g. on mobile generators, in cable dispensers in the ground or on the passenger bridge.

Construction:

Conductor:	tinned copper strands
Insulation:	SABIX®
Color code:	control conductors: red, black, green, yellow power supply conductor: red
Stranding:	control conductors within the power supply conductor
Jacket material:	PUR
Jacket color:	orange
Marking:	SAB BRÖCKSKES · D-VIERSEN · GP 400 SC 50mm ² +4x1.0mm ² 34001321 CE and current meter marking

Technical data:

Nominal voltage:	U ₀ /U 115/200 V
Max. permissible operating voltage*:	U ₀ /U 0.6/1 kV
Testing voltage:	conductor/conductor: 4000 V AC
Min. bending radius:	
fixed installation:	4 x O.D
flexible application:	6 x O.D
Temperature range:	
static:	-50/+90°C
flexible*:	-40/+90°C
Halogen-free:	acc. to IEC 60754-1 + VDE 0482-754-1
Oil resistance:	very good - TMPU acc. to EN 50363-10-2 + VDE 0207-363-10-2
Weather resistance:	very good
Approvals:	CE, EAC, RoHS
Absence of harmful substances:	acc. to RoHS directive of the European Union see page O/30

* using all wires on one potential

Outstanding features:

- low capacity insulation
- abrasion-resistant PUR jacket
- control conductors symmetrically arranged inside power supply conductor
- cold flexible
- halogen-free
- oil resistant
- weather resistant

item no.	AWG/c	outer-ø		cable weight ≈lbs/mft	DC resistance at 20°C max. Ω/km	voltage drop	
		inch	mm			[mV/(A*m)]	
▶ 34001321	2 AWG / 1c + 18 AWG/ 4c	0.614	15.6	394	2 AWG: 0.393 18 AWG: 20.000	2 AWG: 0.786 18 AWG: 40.0	
▶ 34001421	2/0 AWG / 1c + 18 AWG/ 4c	0.697	17.7	538	2/0 AWG: 0.277 18 AWG: 20.000	2/0 AWG: 0.554 18 AWG: 40.0	
▶ 34001521	3/0 AWG / 1c + 18 AWG/ 4c	0.772	19.6	693	3/0 AWG: 0.210 18 AWG: 20.000	3/0 AWG: 0.420 18 AWG: 40.0	

Other dimensions and colors are available on request

400 Mz Ground Power Cables

GP 400 QF

400 Hz Ground Power Supply Cable - QuadFlex

for flexible application

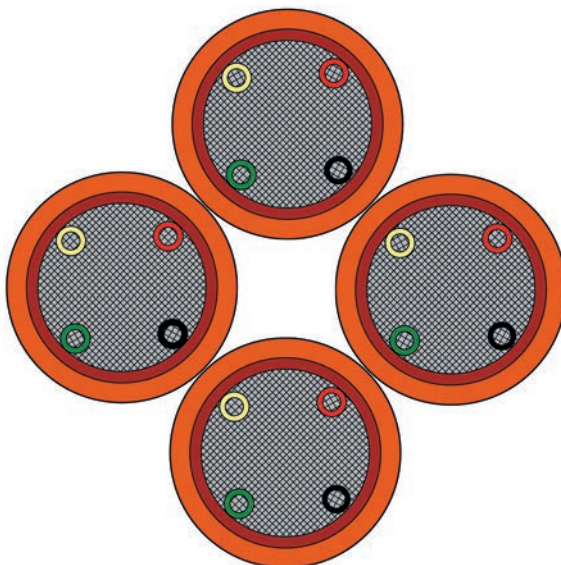

Application: For use in flexible applications, e.g. on mobile generators, in cable dispensers in the ground or on the passenger bridge.

Construction:

Conductor:	tinned copper strands
Insulation:	SABIX®
Color code:	control conductors: red, black, green, yellow power conductor: red
Stranding:	control conductors within the power supply conductor
Jacket material:	PUR
Jacket color:	orange
Stranding:	openly stranded
Marking:	SAB BRÖCKSKES · D-VIERSEN · GP 400 QF 4x(50mm ² +4x1.0mm ²) 34004321 L1 resp. L2 resp. L3 resp. N CE and current meter marking

Technical data:

Nominal voltage:	U ₀ /U 115/200 V
Max. permissible operating voltage*:	U ₀ /U 0.6/1 kV
Testing voltage:	conductor/conductor: 4000 V AC
Min. bending radius:	
<i>fixed installation:</i>	4 x O.D
<i>flexible application:</i>	6 x O.D
Temperature range:	
<i>static:</i>	-50/+90°C
<i>flexible*:</i>	-40/+90°C
Halogen-free:	acc. to IEC 60754-1 + VDE 0482-754-1
Oil resistance:	very good - TMPU acc. to EN 50363-10-2 + VDE 0207-363-10-2
Weather resistance:	very good
Approvals:	CE, EAC, RoHS
Absence of harmful substances:	acc. to RoHS directive of the European Union see page O/30

* using all wires on one potential

Outstanding features:

- low capacity insulation
- abrasion-resistant PUR jacket
- control conductors symmetrically arranged inside power supply conductor
- cold flexible
- halogen-free
- oil resistant
- weather resistant

item no.	AWG/c	outer-ø		cable weight ≈lbs/mft	DC resistance at 20°C max. Ω/km		voltage drop [mV/(A*m)]
		inch	mm		2 AWG:	18 AWG:	
▶ 34004321	4 x (2 AWG + 4 x 18 AWG)	1.476	37.5	1613	2 AWG: 0.393 18 AWG: 20.000	2 AWG: 0.786 18 AWG: 40.0	
▶ 34004421	4 x (2/0 AWG + 4 x 18 AWG)	1.673	42.5	2193	2/0 AWG: 0.277 18 AWG: 20.000	2/0 AWG: 0.554 18 AWG: 40.0	

Other dimensions and colors are available on request

400 Mz Ground Power Cables

GP 400 7F

400 Hz Ground Power supply cable - SevenFlex

for flexible application

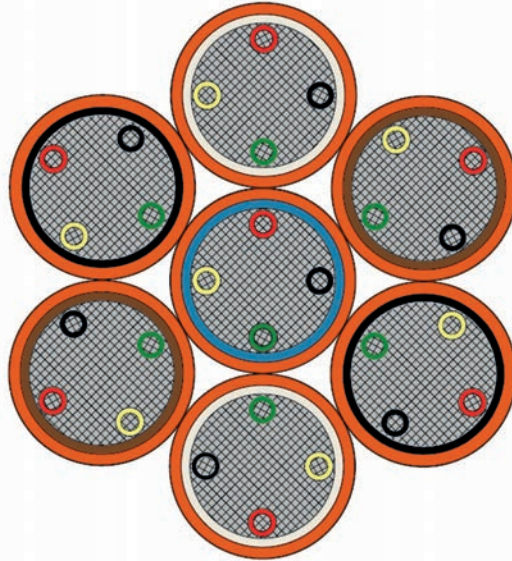

Application: Symmetrical cable with high flexibility. Minimum bending radius (easy to coil even in tight spaces) and high quality electrical performance (low voltage drop and low voltage unbalance). Can be used in long lengths.

Construction:

Conductor:	tinned copper strands
Insulation:	SABIX®
Color code:	control conductors: red, black, green, yellow power supply conductor: red
Stranding:	control conductors within the power supply conductor
Jacket material:	PUR
Jacket color:	orange
Stranding:	openly stranded
Marking:	SAB BRÖCKSKES · D-VIERSEN · Special GP 400 35.0mm ² +4x1.0mm ² 34009006 CE and current meter marking

Technical data:

Nominal voltage:	U ₀ /U 0.6/1kV
Testing voltage:	conductor/conductor: 4000 V AC
Min. bending radius:	
<i>fixed installation:</i>	4 x O.D
<i>flexible application:</i>	6 x O.D
Temperature range:	
<i>static:</i>	-50/+90°C
<i>flexible*:</i>	-40/+90°C
Approvals:	CE, RoHS
Absence of harmful substances:	acc. to RoHS directive of the European Union see page O/30

Outstanding features:



- low capacity insulation
- abrasion-resistant PUR jacket
- control conductors symmetrically arranged inside power supply conductor
- cold flexible
- halogen-free
- oil resistant
- weather resistant

item no.	AWG/c	outer-ø		cable weight ≈lbs/mft	DC resistance at 20°C max. Ω/km		voltage drop [mV/(A*m)]
		inch	mm		2 AWG:	18 AWG:	
▶ 34009006	2 AWG / 7c + 18 AWG / 4c	1.58	40.2	1995	0.554	19.5	2 AWG: 1.108 18 AWG: 39.0

Other dimensions and colors are available on request

400 Mz Ground Power Cables

GP 400 SF

400 Hz Ground Power supply cable - SymmetricalFlex

for flexible application

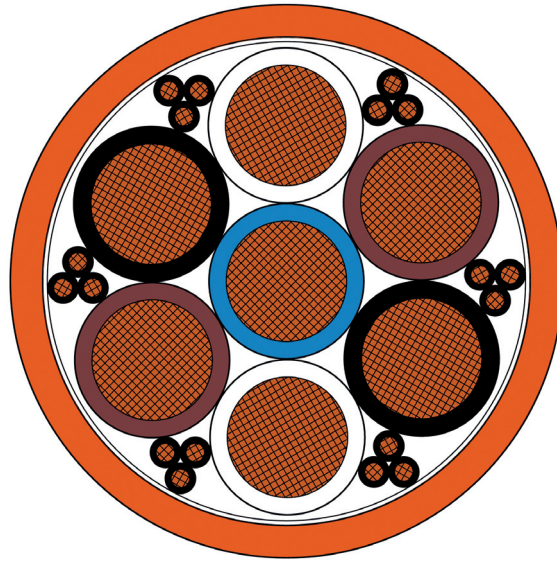

Application: For use as fixed cable with particularly good laying ability or for flexible use without high mechanical stress, e.g. in slow moving drag chains on passenger boarding bridges. Optimized flexibility due to flexible core and jacket materials, thus easy installation and easy handling in the cable dispenser. Depending on the operating conditions, it can also be used as a direct supply line to the aircraft with a connector.

Construction:

Conductor:	bare copper strands
Insulation:	SABIX [®]
Color code:	control conductors: black with numbers 1 - 18 neutral conductor: blue phase conductor: white, brown, black (two conductors of the same color for the phase)
Stranding:	Phase conductors concentrically around neutral core, control cores as tripple in the interstices, triple wrapped with non-woven tape, all elements twisted in specially adjusted layers, non-woven tape overlapping wrapped
Jacket material:	special compound
Jacket color:	orange
Marking:	SAB BRÖCKSKES · D-VIERSEN · GP 400 SF 7x35.0mm ² +6x3x1.0mm ² 34007223 CE and current meter marking

Technical data:

Nominal voltage:	U ₀ /U 0.6/1 kV
Testing voltage:	conductor/conductor: 4000 V AC
Min. bending radius:	
<i>fixed installation:</i>	4 x O.D
<i>flexible application:</i>	6 x O.D
Temperature range:	
<i>static:</i>	-40/+70°C
<i>flexible:</i>	-20/+70°C
Approvals:	CE, EAC, RoHS
Absence of harmful substances:	acc. to RoHS directive of the European Union see page O/30

Outstanding features:



- low capacity insulation
- very smooth handling
- also usable as a supply cable directly on the aircraft
- very good installation in the smallest possible space



Also available with
24 control conductors

item no.	AWG/c	outer-ø		cable weight ≈lbs/mft	DC resistance at 20°C max. Ω/km	voltage drop [mV/(A*m)]
		inch	mm			
▶ 34007123	7 x 4 AWG + (6x3 x 18 AWG)	1.276	32.4	1509	4 AWG: 0.780 18 AWG: 19.500	4 AWG: 1.560 18 AWG: 39.0
▶ 34007223	7 x 2 AWG + (6x3 x 18 AWG)	1.661	42.2	1972	2 AWG: 0.544 18 AWG: 19.500	2 AWG: 1.108 18 AWG: 39.0

400 Mz Ground Power Cables

GP 400 SF S Supply Cable

400 Hz Ground Power Supply Cable

for flexible application

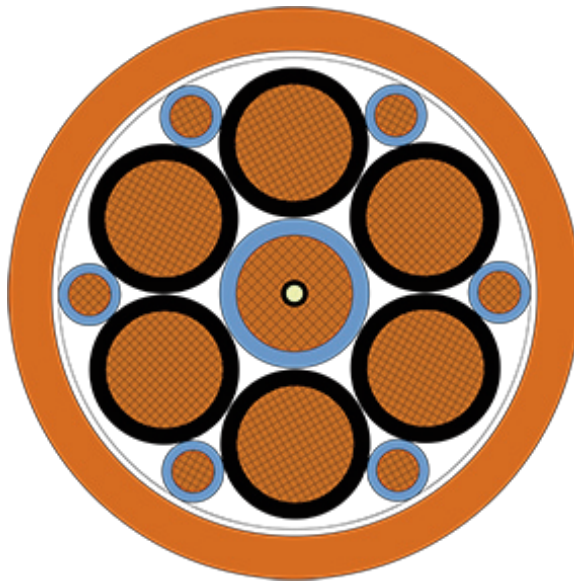

Application: For the application as cable track cables in energy supply chains or as Festoon cable on passenger boarding bridges.

Construction:

Conductor:	tinned copper strands
Insulation:	SABIX®
Color code:	16 AWG: blue 2 AWG: black with numbers, 2 x 1-3 blue
Stranding:	2 AWG: neutral core with strain relief in the core, wrapped with non-woven tape
Wrapping:	non-woven tape
Jacket material:	PUR
Jacket color:	orange
Marking:	SAB BRÖCKSKES · D-VIERSEN · GP 400 SF S 7x35,0mm ² +6x6,0mm ² 34006230 € and current meter marking

Technical data:

Nominal voltage:	U ₀ /U 0.6/1 kV
Testing voltage:	conductor/conductor: 4000 V AC
Min. bending radius: <i>continuously flexible:</i>	7.5 x O.D
Temperature range: <i>static:</i> <i>flexible:</i>	-50/+90°C -40/+90°C
Approvals:	CE, RoHS
Absence of harmful substances:	acc. to RoHS directive of the European Union see page O/30

Outstanding features:



- low capacity insulation
- abrasion resistant PUR jacket
- cold flexible
- halogen-free
- oil resistant
- weather resistant

item no.	AWG	outer-ø		cable weight ≈lbs/mft	DC resistance at 20°C max. Ω/km	
		inch	mm		2 AWG:	16 AWG:
▶ 34006230	16 AWG/7c + 2 AWG/6	1.50	38	2132	0.565	3.39

Other dimensions and colors are available on request

400 Mz Ground Power Cables

GP 400 SF S Control Cable

400 Hz Ground Power Control Cable

for flexible application

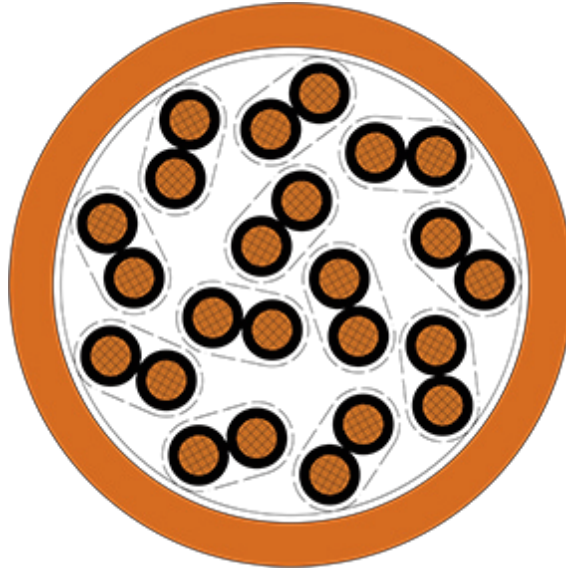

Application: For the application as cable track cables in energy supply chains or as Festoon cable on passenger boarding bridges.

Construction:

Conductor:	bare copper strands, fine wires
Insulation:	SABIX®
Color code:	black with numbers: 1-24
Stranding:	conductors twisted to pairs, optimized twisting of pairs in layers
Jacket material:	PUR
Jacket color:	orange
Marking:	SAB BRÖCKSKES · D-VIERSEN · GP 400 SF S 12x2x1,5mm² 34009028 CE and current meter marking

Technical data:

Nominal voltage:	300/500 V
Testing voltage:	conductor/conductor: 4000 V AC
Min. bending radius: <i>continuously flexible:</i>	7.5 x O.D
Temperature range: <i>static:</i> <i>flexible:</i>	-50/+90°C -40/+90°C
Approvals:	CE, RoHS
Absence of harmful substances:	acc. to RoHS directive of the European Union see page O/30

Outstanding features:



- low capacity insulation
- abrasion resistant PUR jacket
- cold flexible
- halogen-free
- oil resistant
- weather resistant

item no.	AWG/prs	outer-ø		cable weight ≈lbs/mft	DC resistance at 20°C max. Ω/km
		inch	mm		
▶ 34009028	16 AWG/12pr	0.906	23	323	16 AWG: 13.7

Other dimensions and colors are available on request

400 Mz Ground Power Cables

GP 400 SC DC

Ground Power supply cable 28 V DC - SingleCore Direct Current

for flexible application

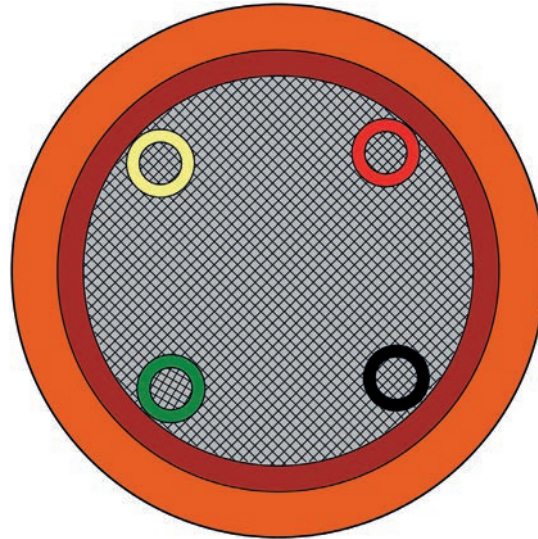

Application: For use in flexible applications, e.g. on mobile generators, in cable dispensers in the ground or on the passenger bridge at 28 V DC.

Construction:

Conductor:	tinned copper strands
Insulation:	SABIX®
Color code:	control conductors: red, black, green, yellow power supply conductor: red
Stranding:	control conductors within the power supply conductor
Jacket material:	PUR
Jacket color:	orange
Marking:	SAB BRÖCKSKES · D-VIERSEN · GP 400 SC DC (120mm ² +4x1.0mm ²) 34001621 CE and current meter marking

Technical data:

Nominal voltage:	28 V DC
Testing voltage:	conductor/conductor: 600 V AC
Min. bending radius:	
<i>fixed installation:</i>	4 x O.D
<i>flexible application:</i>	6 x O.D
Temperature range:	
<i>static:</i>	-50/+90°C
<i>flexible:</i>	-40/+90°C
Halogen-free:	acc. to IEC 60754-1 + VDE 0482-754-1
Oil resistance:	very good - TMPU acc. to EN 50363-10-2 + VDE 0207-363-10-2
Weather resistance:	very good
Approvals:	CE, RoHS
Absence of harmful substances:	acc. to RoHS directive of the European Union see page O/30

Outstanding features:



- low capacity insulation
- abrasion-resistant PUR jacket
- control conductors symmetrically arranged inside power supply conductor
- cold flexible
- halogen-free
- oil resistant
- weather resistant

item no.	AWG/c	outer-ø		cable weight ≈lbs/mft	DC resistance at 20°C max. Ω/km		voltage drop [mV/(A*m)]
		inch	mm		4/0 AWG:	18 AWG:	
▶ 34001621	4/0 AWG/ 1c + 18 AWG/ 4c	0.874	22.2	894	0.164	20.000	4/0 AWG: 0.328 18 AWG: 40.0

Other dimensions and colors are available on request

400 Mz Ground Power Cables

GP 400 SF 28V DC

400 Hz Ground Power supply cable - 28 V DC

for flexible application

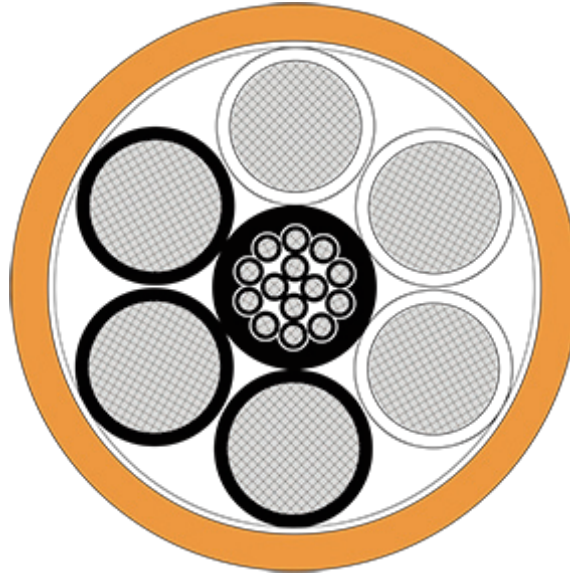

Application: For the application as fixed supply cable with optimised installation or for a flexible hand-held application without elevated mechanical stress for example mobile GPUs. Excellent flexibility due to smooth core and sheath materials make possible an easy laying and handling.

Construction:

Conductor:	tinned copper strands, fine wires
Insulation:	SABIX®
Color code:	1.0 mm ² : black conductors with consecutive numbers 1 - 14 40 mm ² : white conductors with consecutive numbers 1 - 3, black conductors with consecutive numbers 1 - 3
Stranding:	in layers
Jacket material:	PVC
Jacket color:	orange
Marking:	SAB BRÖCKSKES · D-VIERSEN · GP 400 SF 28V DC 6x40.0mm ² +14x1.0mm ² 34009020 €€ and current meter marking

Technical data:

Nominal voltage:	28 V DC
Testing voltage:	conductor/conductor: 600 V AC
Min. bending radius:	
<i>fixed installation:</i>	4 x O.D
<i>flexible application:</i>	6 x O.D
Temperature range:	
<i>static:</i>	-50/+90°C
<i>flexible:</i>	-40/+90°C
Oil resistance:	acc. to internal standard
Approvals:	CE, RoHS
Absence of harmful substances:	acc. to RoHS directive of the European Union see page O/30

Outstanding features:



- low capacity insulation
- extremely flexible and smooth handling
- also usable as supply cable on the aircraft itself
- very good installation in narrowest spaces
- good resistance characteristics also against wear and tear

item no.	Dimensions	outer-ø		cable weight ≈lbs/mft	DC resistance at 20°C max. Ω/km
		inch	mm		
▶ 34009020	6 x 40.0 + 14 x 1.0	min. 1.417 max. 1.496	min. 36 max. 38	1955	40 mm ² : 0.500 1.0 mm ² : 20.0

Other dimensions and colors are available on request

400 Mz Ground Power Cables

SAB 400 Hz cable for mobile GPUs with connectors

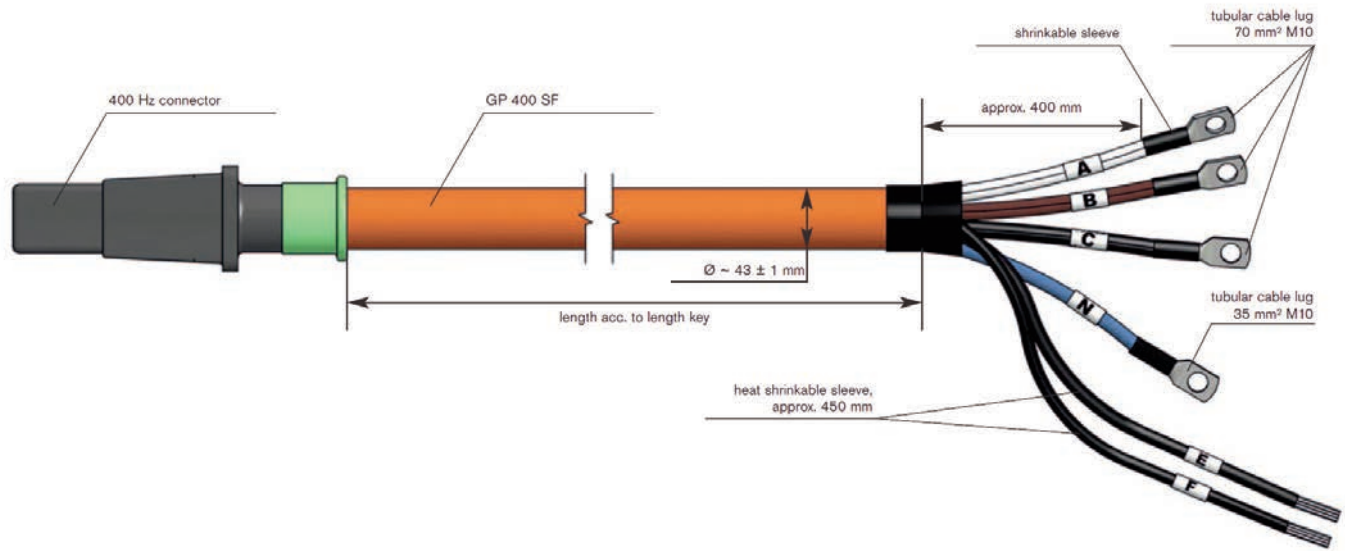

Pin Assignment:

400 Hz Connector	Cable	Connection Piece
pin A	2 x wh (35 mm ²)	tubular cable lug 70 mm ² , M10
pin B	2 x bn (35 mm ²)	tubular cable lug 70 mm ² , M10
pin C	2 x bk (35 mm ²)	tubular cable lug 70 mm ² , M10
pin N	1 x bu (35 mm ²)	tubular cable lug 35 mm ² , M10
pin E	conductors 1-9 (1 mm ²)	cores pulled into shrinkable sleeves, core ends untreated
pin F	conductors 10-18 (1 mm ²)	

Weight:

connector and tubular cable lugs	Cable
approx. 3 kg	approx. 3.2 kg/m

Configuration examples:

item no.	length "L" in cm
▶ S3400-3003-01000	100
▶ S3400-3003-02000	200

400 Mz Ground Power Cables

Plug'n'Play - ready harnessed with plug connector

Ready-to-connect ground power cables with plug connectors



SAB also supplies 400 Hz cables ready for installation.

Various 400 Hz connectors available.

- on request also with cable lugs.
- each assembly is packed safely and individually.
- each product is tested for function.
- on request with test report for 100% documentation.



Cables for Airport Equipment

Production possibilities

Flexible cables and wires “Made in Germany”

As a leading manufacturer we develop and produce cables for industrial purposes.

Our wide range of materials offer a lot of possibilities for your individual product requirement.

The following survey shows an extract of our production possibilities:

Conductor Materials:

- ✓ bare copper
- ✓ tinned copper
- ✓ silver plated copper
- ✓ nickel plated copper
- ✓ nickel
- ✓ nickel pure
- ✓ compensating cable alloys

Insulation and Jacketing Materials:

- ✓ PVC
- ✓ Polyethylene
- ✓ Polypropylene
- ✓ Polyurethane
- ✓ TPE
- ✓ SABIX® (zero halogen)
- ✓ Besilen® - Silicone
- ✓ FEP, ETFE, PFA, PTFE
- ✓ PI foil
- ✓ Fiberglass

Temperature Ranges:

- Thermoplastic Elastomers
- ✓ -50°C up to +145°C
- SABIX®
- ✓ -50°C up to +220°C
- Besilen® - Silicone
- ✓ -40°C up to +220°C
- FEP, ETFE, PFA
- ✓ -90°C up to +260°C
- Fiberglass
- ✓ up to +600°C

Conductors:

- ✓ cross sections 0.055 - 300 mm²
- ✓ unshielded and shielded over 100 conductors

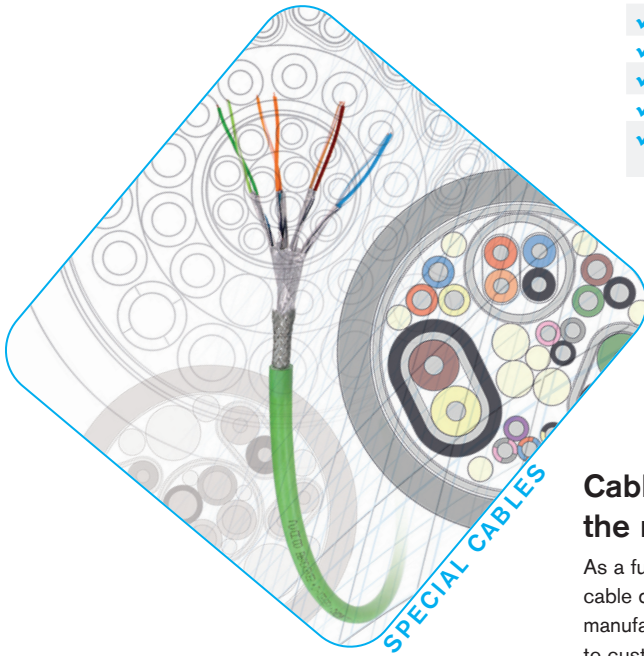

Cable assemblies directly from the manufacturer SAB:

As a full service partner, we are able to offer cable design and production as well as the manufacturing of cable assembly according to customer's request. Please trust on our experience for decades in the treatment of cables and connectors.

- ✓ cable assemblies according to customer's demands
- ✓ complete cable assemblies
- ✓ UL certified assemblies
- ✓ helix cables
- ✓ HV measuring assemblies

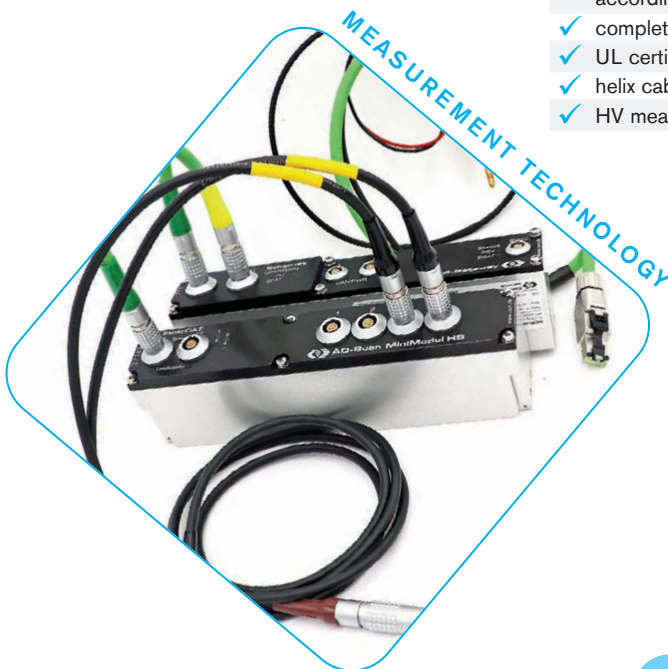

Measuring technology for industrial applications

Manufacturer of temperature sensors for industrial applications with 75 years of experience!

- ✓ mineral insulated thermocouples
- ✓ mineral insulated resistance thermometers
- ✓ temperature sensors
- ✓ mobile high voltage measuring technology
- ✓ temperature sensors for vehicle testing

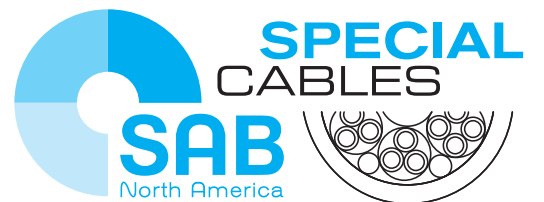

344 Kaplan Drive
Fairfield, NJ 07004
Toll Free: 866-722-2974
www.sabcable.com
info@sabcable.com